

Discriminative Feature Extraction and Dimension Reduction

- PCA, LDA and LSA

Berlin Chen



Graduate Institute of Computer Science & Information Engineering
National Taiwan Normal University

References:

1. *Introduction to Machine Learning*, Chapter 6
2. *Data Mining: Concepts, Models, Methods and Algorithms*, Chapter 3

Introduction (1/3)

- Goal: discover significant patterns or features from the input data
 - Salient feature selection or dimensionality reduction

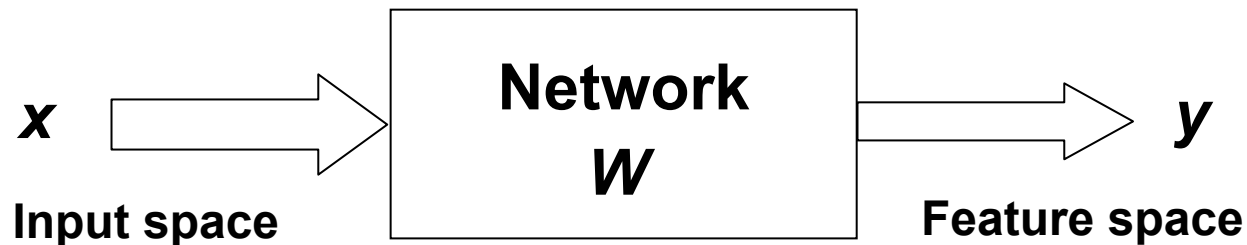

- Compute an input-output mapping based on some desirable properties

Introduction (2/3)

- Principal Component Analysis (PCA)
- Linear Discriminant Analysis (LDA)
- Latent Semantic Analysis (LSA)
- Heteroscedastic Discriminant Analysis (HDA)

Introduction (3/3)

- Formulation for discriminative feature extraction
 - Model-free (nonparametric)
 - Without prior information: e.g., PCA
 - With prior information: e.g., LDA
 - Model-dependent (parametric)
 - E.g., PLSA (Probabilistic Latent Semantic Analysis) with EM (Expectation-Maximization), MCE (Minimum Classification Error) Training

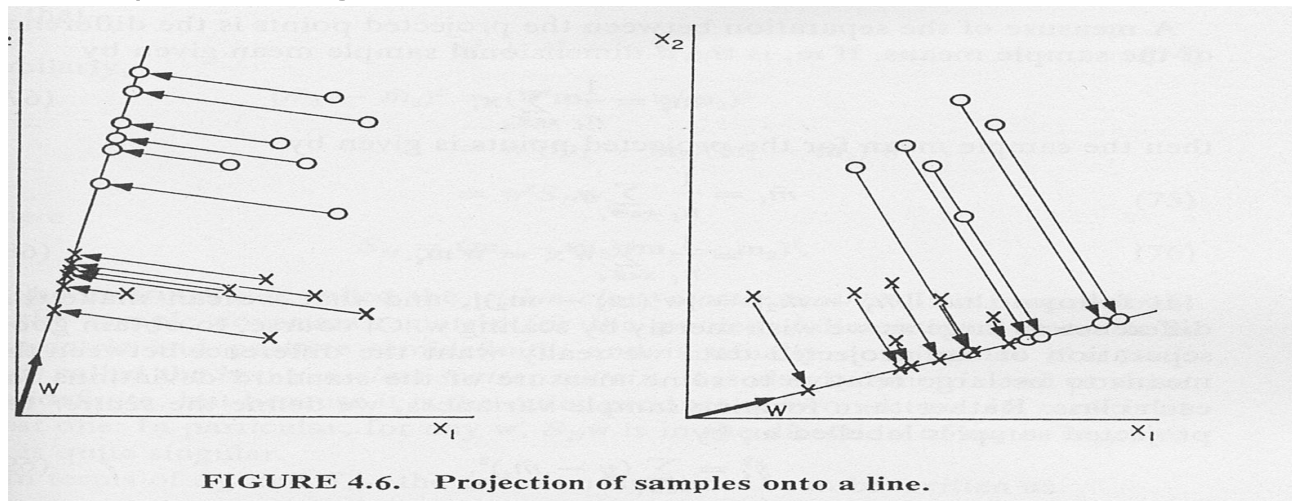

Principal Component Analysis (PCA) (1/2)

Pearson, 1901

- Known as Karhunen-Loève Transform (1947, 1963)
 - Or Hotelling Transform (1933)
- A standard technique commonly used for data reduction in statistical pattern recognition and signal processing
- A transform by which the data set can be represented by reduced number of effective features and still retain the most intrinsic information content
 - A small set of features to be found to represent the data samples accurately
- Also called “Subspace Decomposition”, “Factor Analysis” ..

Principal Component Analysis (PCA) (2/2)

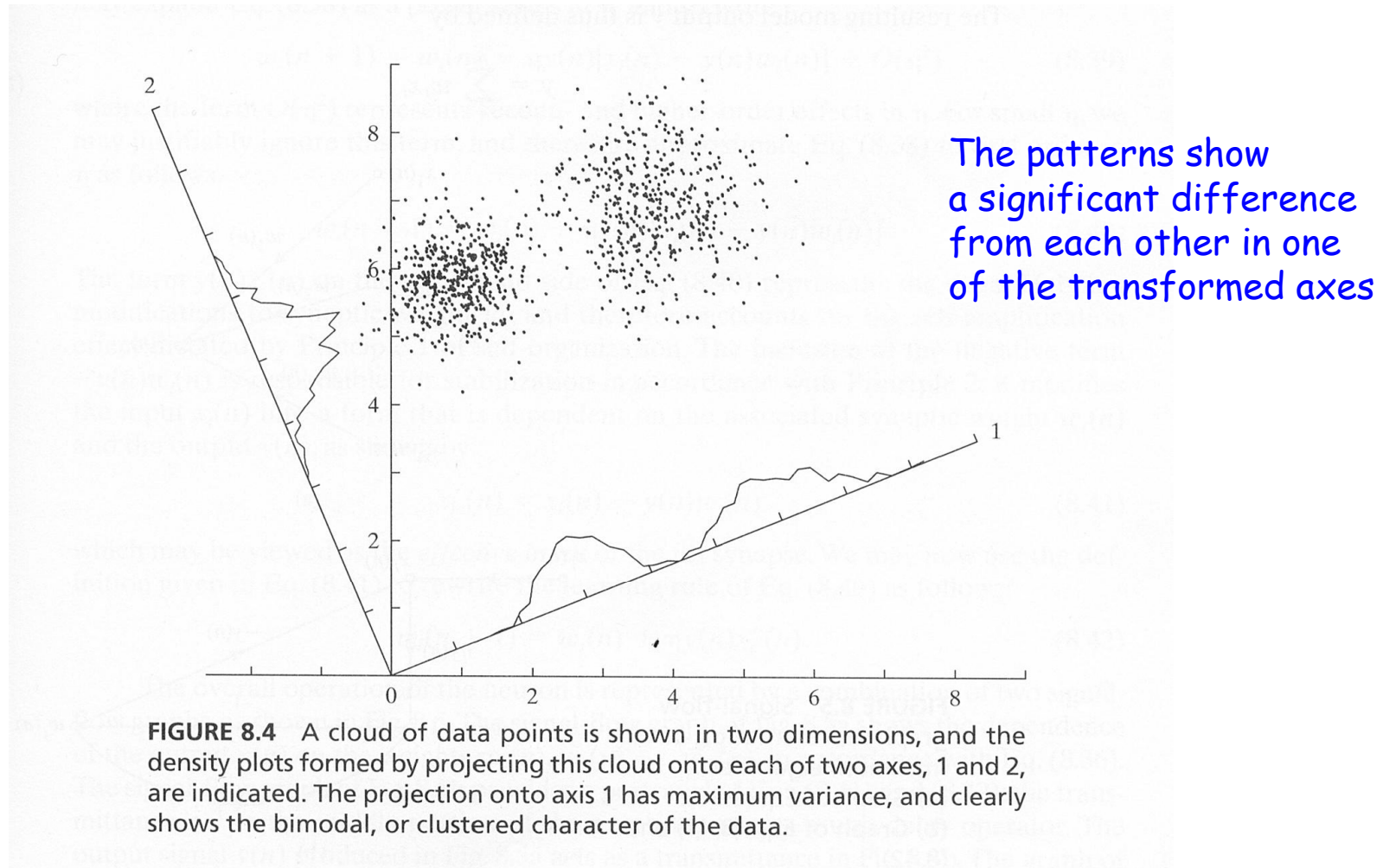

PCA Derivations (1/13)

- Suppose \mathbf{x} is an n -dimensional zero mean random vector, $\boldsymbol{\mu} = E_{\mathbf{x}} \{ \mathbf{x} \} = \mathbf{0}$
 - If \mathbf{x} is not zero mean, we can subtract the mean before processing the following analysis

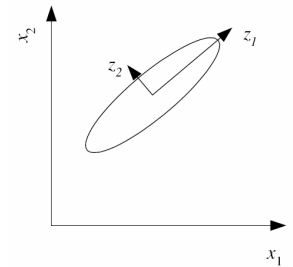

- \mathbf{x} can be represented without error by the summation of n linearly independent vectors

$$\mathbf{x} = \sum_{i=1}^n y_i \boldsymbol{\varphi}_i = \boldsymbol{\Phi} \mathbf{y} \quad \text{where} \quad \mathbf{y} = [y_1 \quad \cdot \quad y_i \quad \cdot \quad y_n]^T$$
$$\boldsymbol{\Phi} = [\boldsymbol{\varphi}_1 \quad \cdot \quad \boldsymbol{\varphi}_i \quad \cdot \quad \boldsymbol{\varphi}_n]$$

The i -th component
in the feature (mapped) space

The basis vectors

PCA Derivations (2/13)

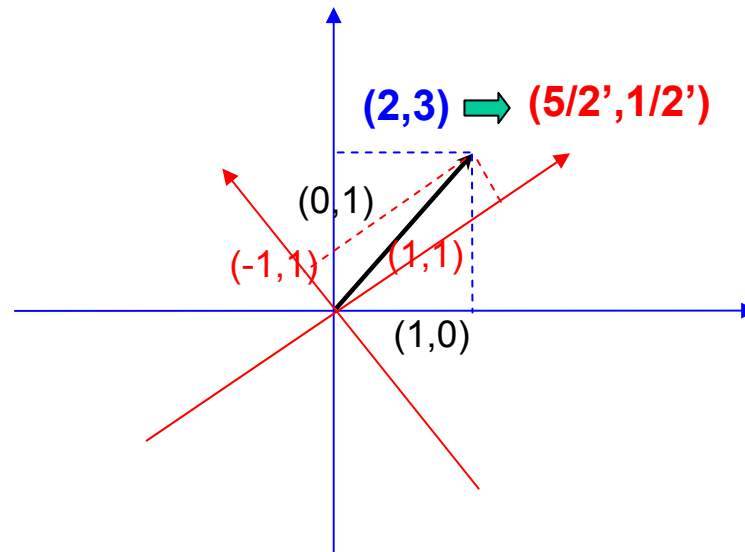

$$\begin{bmatrix} 2 \\ 3 \end{bmatrix} = 2 \begin{bmatrix} 1 \\ 0 \end{bmatrix} + 3 \begin{bmatrix} 0 \\ 1 \end{bmatrix} = \frac{5}{2} \begin{bmatrix} 1 \\ 1 \end{bmatrix} + \frac{1}{2} \begin{bmatrix} -1 \\ 1 \end{bmatrix} = 1 \begin{bmatrix} 1 \\ 2 \end{bmatrix} + 1 \begin{bmatrix} 1 \\ 1 \end{bmatrix}$$

orthogonal basis sets

PCA Derivations (3/13)

- Further assume the column (basis) vectors of the matrix Φ form an orthonormal set

$$\varphi_i^T \varphi_j = \begin{cases} 1 & \text{if } i = j \\ 0 & \text{if } i \neq j \end{cases}$$

- Such that y_i is equal to the projection of \mathbf{x} on φ_i

$$\forall_i \quad y_i = \mathbf{x}^T \varphi_i = \varphi_i^T \mathbf{x}$$

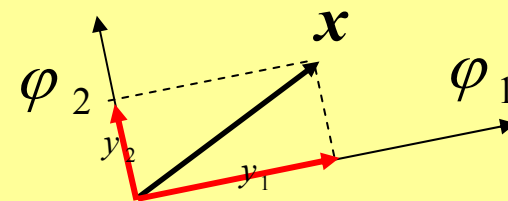

$$y_1 = \|\mathbf{x}\| \cos \theta_1 = \|\mathbf{x}\| \frac{\varphi_1^T \mathbf{x}}{\|\mathbf{x}\| \|\varphi_1\|} = \varphi_1^T \mathbf{x}$$

, where $\|\varphi_1\| = 1$

PCA Derivations (4/13)

– Further assume the column (basis) vectors of the matrix Φ form an orthonormal set

- y_i also has the following properties

– Its mean is zero, too

$$E\{y_i\} = E\{\varphi_i^T \mathbf{x}\} = \varphi_i^T E\{\mathbf{x}\} = \varphi_i^T \mathbf{0} = 0$$

– Its variance is

$$\begin{aligned} \sigma_i^2 &= E\{y_i^2\} - [E\{y_i\}]^2 = E\{y_i^2\} = E\{\varphi_i^T \mathbf{x} \mathbf{x}^T \varphi_i\} = \varphi_i^T E\{\mathbf{x} \mathbf{x}^T\} \varphi_i \\ &= \varphi_i^T \mathbf{R} \varphi_i \quad [\mathbf{R} \text{ is the (auto-)correlation matrix of } \mathbf{x}] \end{aligned}$$

- The correlation between two projections y_i and y_j

$$\begin{aligned} \text{is } E\{y_i y_j\} &= E\{(\varphi_i^T \mathbf{x})(\varphi_j^T \mathbf{x})\} = E\{\varphi_i^T \mathbf{x} \mathbf{x}^T \varphi_j\} \\ &= \varphi_i^T E\{\mathbf{x} \mathbf{x}^T\} \varphi_j = \varphi_i^T \mathbf{R} \varphi_j \end{aligned}$$

$$\begin{aligned} \Sigma &= E[(\mathbf{x} - \boldsymbol{\mu})(\mathbf{x} - \boldsymbol{\mu})^T] \\ &\approx \left(\frac{1}{N} \sum_{i=1}^N \mathbf{x}_i \mathbf{x}_i^T \right) - \boldsymbol{\mu} \boldsymbol{\mu}^T \\ \mathbf{R} &= E\{\mathbf{x} \mathbf{x}^T\} = \frac{1}{N} \sum_i \mathbf{x}_i \mathbf{x}_i^T \end{aligned}$$

PCA Derivations (5/13)

- **Minimum Mean-Squared Error Criterion**
 - We want to choose only m of $\boldsymbol{\varphi}_i$'s that we still can approximate \mathbf{x} well in **mean-squared error criterion**

original vector $\mathbf{x} = \sum_{i=1}^n y_i \boldsymbol{\varphi}_i = \sum_{i=1}^m y_i \boldsymbol{\varphi}_i + \sum_{j=m+1}^n y_j \boldsymbol{\varphi}_j$

reconstructed vector $\hat{\mathbf{x}}(m) = \sum_{i=1}^m y_i \boldsymbol{\varphi}_i$

$$\bar{\varepsilon}(m) = E \left\{ \left\| \hat{\mathbf{x}}(m) - \mathbf{x} \right\|^2 \right\} = E \left\{ \left(\sum_{j=m+1}^n y_j \boldsymbol{\varphi}_j^T \right) \left(\sum_{k=m+1}^n y_k \boldsymbol{\varphi}_k \right) \right\}$$

$$= E \left\{ \sum_{j=m+1}^n \sum_{k=m+1}^n y_j y_k \boldsymbol{\varphi}_j^T \boldsymbol{\varphi}_k \right\}$$

$$\begin{aligned} E\{y_j\} &= 0 \\ \sigma_j^2 &= E\{y_j^2\} - [E\{y_j\}]^2 \\ &= E\{y_j^2\} \end{aligned}$$

$$= \sum_{j=m+1}^n E\{y_j^2\}$$

$$\because \boldsymbol{\varphi}_j^T \boldsymbol{\varphi}_k = \begin{cases} 1 & \text{if } j = k \\ 0 & \text{if } j \neq k \end{cases}$$

$$= \sum_{j=m+1}^n \sigma_j^2 = \sum_{j=m+1}^n \boldsymbol{\varphi}_j^T \mathbf{R} \boldsymbol{\varphi}_j$$

We should discard the bases where the projections have lower variances

PCA Derivations (6/13)

- Minimum Mean-Squared Error Criterion

- If the orthonormal (basis) set φ_i 's is selected to be the eigenvectors of the correlation matrix \mathbf{R} , associated with eigenvalues λ_i 's

- They will have the property that:

is real and symmetric, therefore its eigenvectors \mathbf{R} form a orthonormal set

$$\mathbf{R} \varphi_j = \lambda_j \varphi_j$$

\mathbf{R} is positive definite ($\mathbf{x}^T \mathbf{R} \mathbf{x} > 0$)
=> all eigenvalues are positive

- Such that the mean-squared error mentioned above will be

$$\begin{aligned} \bar{\varepsilon}(m) &= \sum_{j=m+1}^n \sigma_j^2 \\ &= \sum_{j=m+1}^n \varphi_j^T \mathbf{R} \varphi_j = \sum_{j=m+1}^n \varphi_j^T \lambda_j \varphi_j = \sum_{j=m+1}^n \lambda_j \end{aligned}$$

PCA Derivations (7/13)

- Minimum Mean-Squared Error Criterion

- If the eigenvectors are retained associated with the m largest eigenvalues, the mean-squared error will be

$$\bar{\mathcal{E}}_{\text{eigen}}(m) = \sum_{j=m+1}^n \lambda_j \quad (\text{where } \lambda_1 \geq \dots \geq \lambda_m \geq \dots \geq \lambda_n \geq 0)$$

- Any two projections y_i and y_j will be mutually uncorrelated

$$\begin{aligned} E\{y_i y_j\} &= E\left\{(\boldsymbol{\varphi}_i^T \mathbf{x})(\boldsymbol{\varphi}_j^T \mathbf{x})^T\right\} = E\left\{\boldsymbol{\varphi}_i^T \mathbf{x} \mathbf{x}^T \boldsymbol{\varphi}_j\right\} \\ &= \boldsymbol{\varphi}_i^T E\left\{\mathbf{x} \mathbf{x}^T\right\} \boldsymbol{\varphi}_j = \boldsymbol{\varphi}_i^T \mathbf{R} \boldsymbol{\varphi}_j = \lambda_j \boldsymbol{\varphi}_i^T \boldsymbol{\varphi}_j = 0 \end{aligned}$$

- Good news for most statistical modeling approaches
 - Gaussians and diagonal matrices

$$\begin{aligned} \boldsymbol{\Sigma} &= E[(\mathbf{x} - \boldsymbol{\mu})(\mathbf{x} - \boldsymbol{\mu})^T] \\ &\approx \left(\frac{1}{N} \sum_{i=1}^N \mathbf{x}_i \mathbf{x}_i^T\right) - \boldsymbol{\mu} \boldsymbol{\mu}^T \\ \mathbf{R} &= E\{\mathbf{x} \mathbf{x}^T\} = \frac{1}{N} \sum_i \mathbf{x}_i \mathbf{x}_i^T \end{aligned}$$

$$\begin{bmatrix} \sigma_{11} & \sigma_{12} & \cdot & \cdot & \sigma_{1n} \\ \sigma_{22} & \sigma_{22} & \cdot & \cdot & \cdot \\ \cdot & \cdot & \cdot & \cdot & \cdot \\ \cdot & \cdot & \cdot & \cdot & \cdot \\ \sigma_{n1} & \sigma_{n2} & \cdot & \cdot & \sigma_{nm} \end{bmatrix}$$

PCA Derivations (8/13)

- An two-dimensional example of Principle Component Analysis

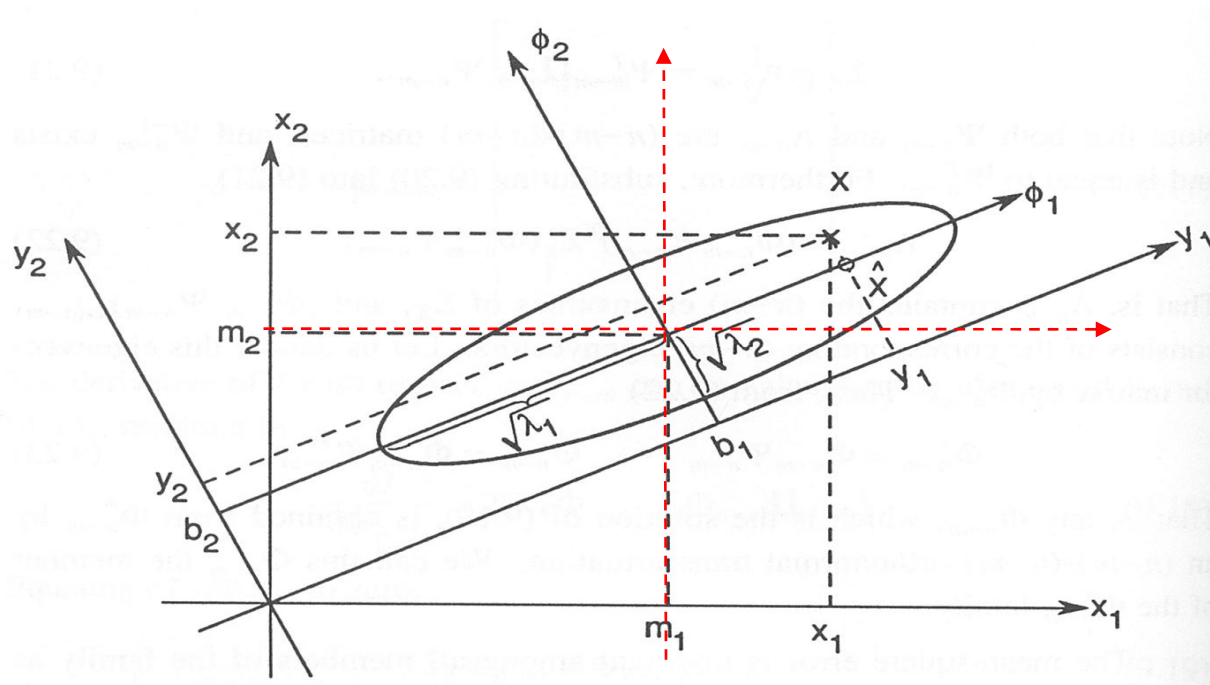

PCA Derivations (9/13)

- Minimum Mean-Squared Error Criterion

- It can be proved that $\bar{\varepsilon}_{eigen}(m)$ is the optimal solution under the mean-squared error criterion

$$\delta_{jk} = \begin{cases} 1 & \text{if } j = k \\ 0 & \text{if } j \neq k \end{cases}$$

Objective function

To be minimized

constraints

Define: $J = \sum_{j=m+1}^n \boldsymbol{\varphi}_j^T \mathbf{R} \boldsymbol{\varphi}_j - \sum_{j=m+1}^n \sum_{k=m+1}^n \mu_{jk} (\boldsymbol{\varphi}_j^T \boldsymbol{\varphi}_k - \delta_{jk})$

$$\frac{\partial \boldsymbol{\varphi}^T \mathbf{R} \boldsymbol{\varphi}}{\partial \boldsymbol{\varphi}} = 2\mathbf{R}\boldsymbol{\varphi}$$

Take derivation

$$\Rightarrow \forall_{m+1 \leq j \leq n} \frac{\partial J}{\partial \boldsymbol{\varphi}_j} = 2\mathbf{R}\boldsymbol{\varphi}_j - 2 \sum_{k=m+1}^n \mu_{jk} \boldsymbol{\varphi}_k = \mathbf{0} \quad \left(\text{where } \boldsymbol{\mu}_j^T = [\mu_{j, m+1} \dots \mu_{j, n}] \right)$$

$$\Rightarrow \forall_{m+1 \leq j \leq n} \mathbf{R}\boldsymbol{\varphi}_j = \boldsymbol{\Phi}_{n-m} \boldsymbol{\mu}_j \quad \left(\text{where } \boldsymbol{\Phi}_{n-m} = [\boldsymbol{\varphi}_{m+1} \dots \boldsymbol{\varphi}_n] \right)$$

$$\Rightarrow \mathbf{R}[\boldsymbol{\varphi}_{m+1} \dots \boldsymbol{\varphi}_n] = \boldsymbol{\Phi}_{n-m} [\boldsymbol{\mu}_{m+1} \dots \boldsymbol{\mu}_n]$$

$$\Rightarrow \mathbf{R}\boldsymbol{\Phi}_{n-m} = \boldsymbol{\Phi}_{n-m} \mathbf{U}_{n-m} \quad \left(\text{where } \mathbf{U}_{n-m} = [\boldsymbol{\mu}_{m+1} \dots \boldsymbol{\mu}_n] \right)$$

Have a particular solution if \mathbf{U}_{n-m} is a diagonal matrix and its diagonal elements is the eigenvalues $\lambda_{m+1} \dots \lambda_n$ of \mathbf{R} and $\boldsymbol{\varphi}_{m+1} \dots \boldsymbol{\varphi}_n$ is their corresponding eigenvectors

PCA Derivations (10/13)

- Given an input vector \mathbf{x} with dimension m
 - Try to construct a linear transform Φ' (Φ' is an $n \times m$ matrix $m < n$) such that the truncation result, $\Phi'^T \mathbf{x}$, is optimal in mean-squared error criterion

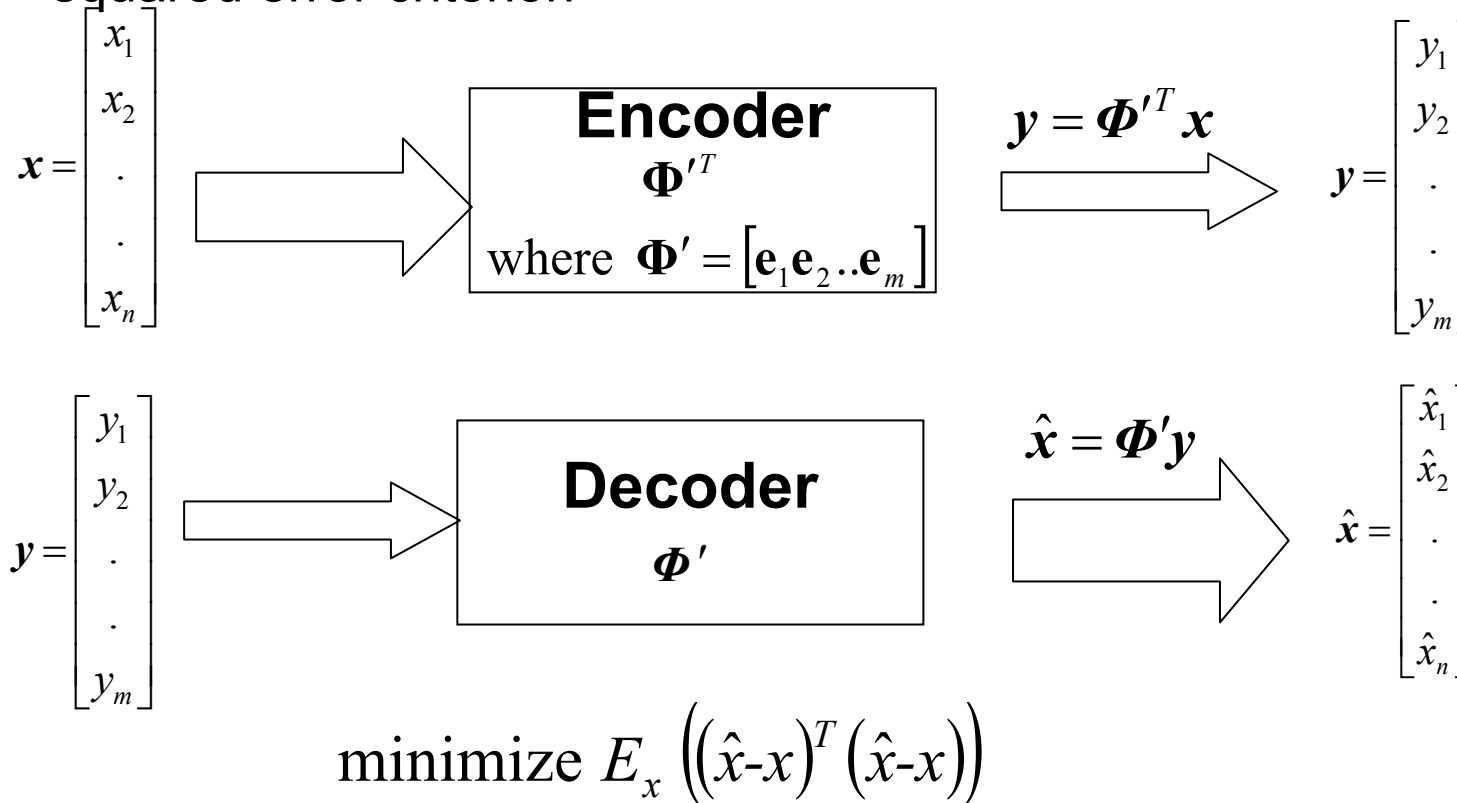

PCA Derivations (11/13)

- Data compression in communication

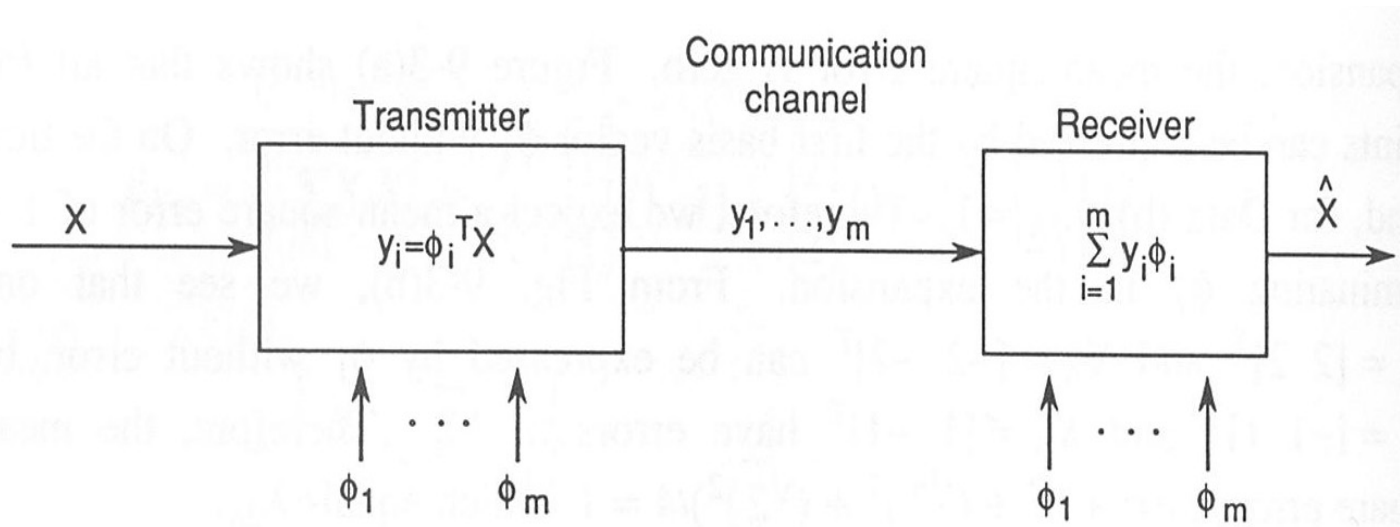

- PCA is an optimal transform for signal representation and dimensional reduction, but not necessary for classification tasks, such as speech recognition **? (To be discussed later on)**
- PCA needs no prior information (e.g. class distributions of output information) of the sample patterns

PCA Derivations (12/13)

- Scree Graph

- The plot of variance as a function of the number of eigenvectors kept

- Select m such that
$$\frac{\lambda_1 + \lambda_2 + \dots + \lambda_m}{\lambda_1 + \lambda_2 + \dots + \lambda_m + \dots + \lambda_n} \geq \text{Threshold}$$

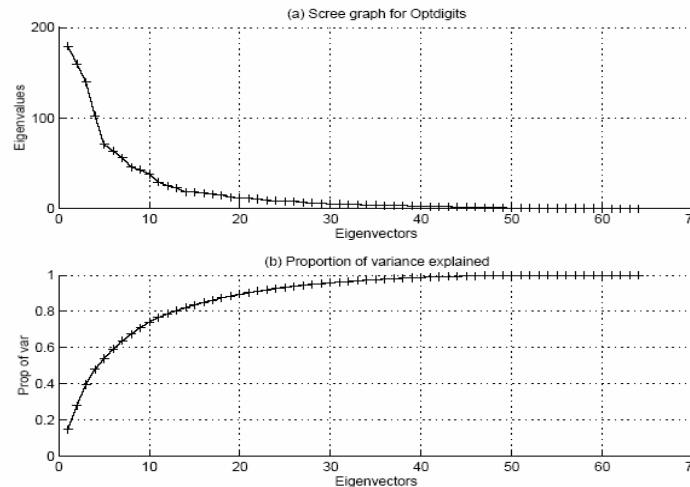

- Or select those eigenvectors with eigenvalues larger than the average input variance (average eigenvalue)

$$\lambda_m \geq \frac{1}{n} \sum_{i=1}^n \lambda_i$$

PCA Derivations (13/13)

- PCA finds a linear transform \mathbf{W} such that the **sum of average between-class variation and average within-class variation** is maximal

$$J(\mathbf{W}) = |\tilde{\mathbf{S}}| \stackrel{?}{=} |\tilde{\mathbf{S}}_w + \tilde{\mathbf{S}}_b| = |\mathbf{W}^T \mathbf{S}_w \mathbf{W} + \mathbf{W}^T \mathbf{S}_b \mathbf{W}|$$

$$\mathbf{S} = \frac{1}{N} \sum_i (\mathbf{x}_i - \bar{\mathbf{x}})(\mathbf{x}_i - \bar{\mathbf{x}})^T$$

i ← sample index

$$\mathbf{S}_w = \frac{1}{N} \sum_j N_j \boldsymbol{\Sigma}_j$$

j ← class index

$$\mathbf{S}_b = \frac{1}{N} \sum_j N_j (\bar{\mathbf{x}}_j - \bar{\mathbf{x}})(\bar{\mathbf{x}}_j - \bar{\mathbf{x}})^T$$

$$\tilde{\mathbf{S}}_w = \mathbf{W}^T \mathbf{S}_w \mathbf{W}$$

$$\tilde{\mathbf{S}}_b = \mathbf{W}^T \mathbf{S}_b \mathbf{W}$$

Try to show that:
 $\mathbf{S} = \mathbf{S}_w + \mathbf{S}_b$

PCA Examples: Data Analysis

- Example 1: principal components of some data points

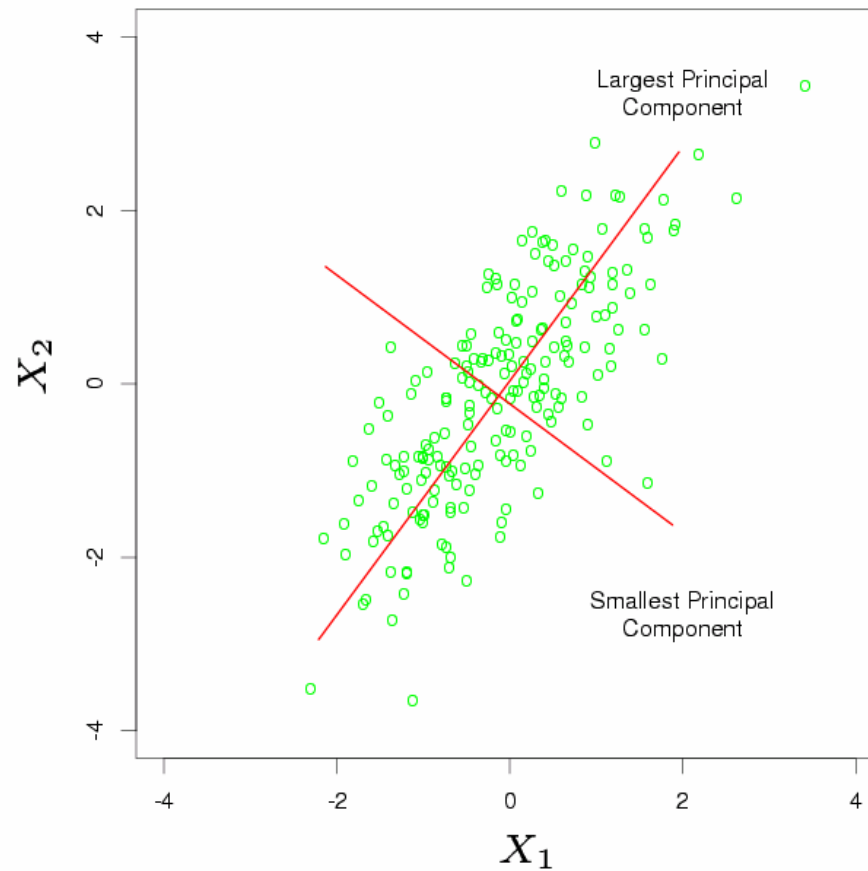

PCA Examples: Feature Transformation

- Example 2: feature transformation and selection

**Correlation matrix
for old feature
dimensions**

TABLE 3.2 The correlation matrix for Iris data

	Feature 1	Feature 2	Feature 3	Feature 4
Feature 1	1.0000	-0.1094	0.8718	0.8180
Feature 2	-0.1094	1.0000	-0.4205	-0.3565
Feature 3	0.8718	-0.4205	1.0000	0.9628
Feature 4	0.8180	-0.3565	0.9628	1.0000

New feature dimensions

TABLE 3.3 The eigenvalues for Iris data

Feature	Eigenvalue
Feature 1	2.91082
Feature 2	0.92122
Feature 3	0.14735
Feature 4	0.02061

$$R = (2.91082 + 0.92122) / (2.91082 + 0.92122 + 0.14735 + 0.02061) \\ = 0.958 > 0.95$$

threshold for information content reserved

PCA Examples: Image Coding (1/2)

- Example 3: Image Coding

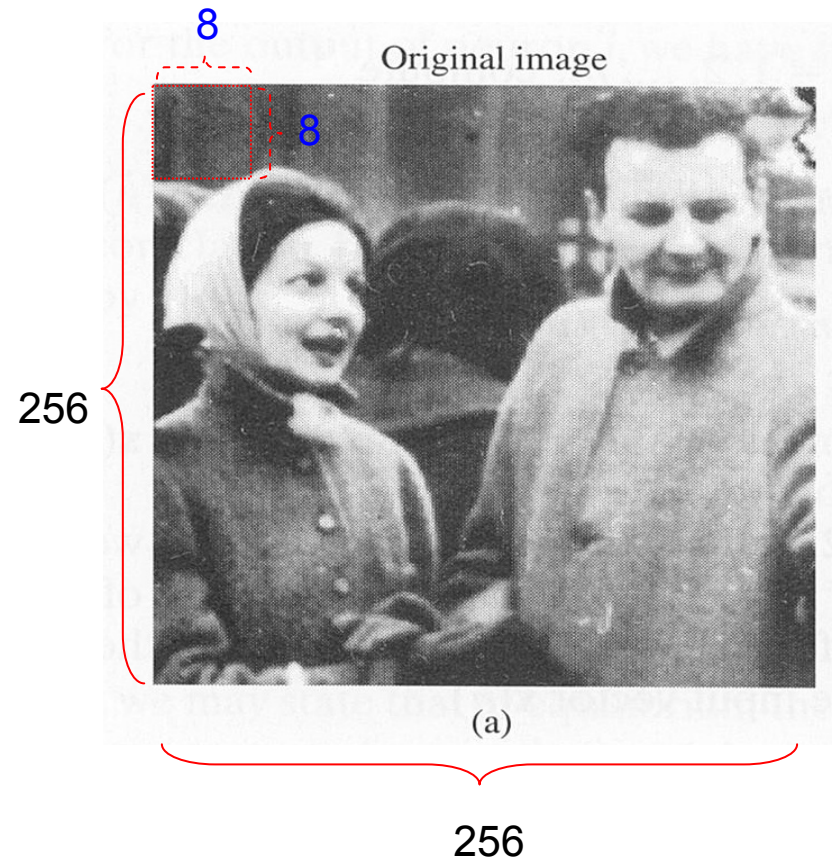

PCA Examples: Eigenface (1/4)

- Example 4: Eigenface in face recognition (Turk and Pentland, 1991)
 - Consider an individual image to be a linear combination of a small number of face components or “eigenface” derived from a set of reference images

$$\mathbf{x}_1 = \begin{bmatrix} x_{1,1} \\ x_{1,2} \\ \cdot \\ \cdot \\ x_{1,n} \end{bmatrix}, \mathbf{x}_2 = \begin{bmatrix} x_{2,1} \\ x_{2,2} \\ \cdot \\ \cdot \\ x_{2,n} \end{bmatrix}, \dots, \mathbf{x}_L = \begin{bmatrix} x_{L,1} \\ x_{L,2} \\ \cdot \\ \cdot \\ x_{L,n} \end{bmatrix}$$

- Steps
 - Convert each of the L reference images into a vector of floating point numbers representing light intensity in each pixel
 - Calculate the covariance/correlation matrix between these reference vectors
 - Apply Principal Component Analysis (PCA) find the eigenvectors of the matrix: the eigenfaces
 - Besides, the vector obtained by averaging all images are called “eigenface 0”. The other eigenfaces from “eigenface 1” onwards model the variations from this average face

PCA Examples: Eigenface (2/4)

- Example 4: Eigenface in face recognition (cont.)
 - Steps
 - Then the faces are then represented as eigenvoice 0 plus a linear combination of the remain K ($K \leq L$) eigenfaces
 - The Eigenface approach persists the minimum mean-squared error criterion
 - Incidentally, the eigenfaces are not only themselves usually plausible faces, but also directions of variations between faces

$$\hat{\mathbf{x}}_i = \bar{\mathbf{x}} + w_{i,1} \mathbf{e}(1) + w_{i,2} \mathbf{e}(2) + \dots + w_{i,K} \mathbf{e}(K)$$
$$\Rightarrow \mathbf{y}_i = [1, w_{i,1}, w_{i,2}, \dots, w_{i,K}]$$

Feature vector of a person i

PCA Examples: Eigenface (3/4)

Face images as the training set

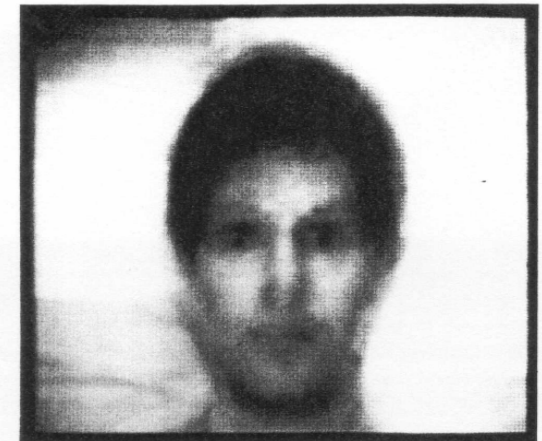

The averaged face

PCA Examples: Eigenface (4/4)

Seven eigenfaces derived from the training set



(Indicate directions of variations between faces)

A projected Face image

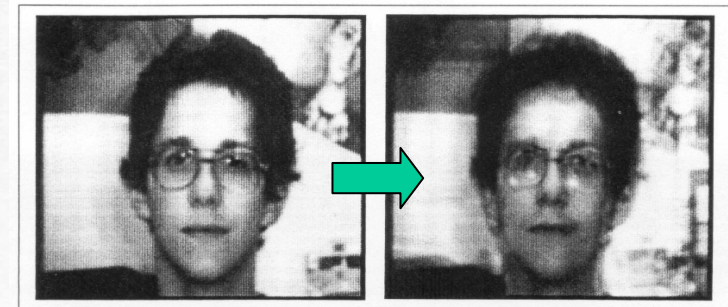

Figure 3. An original face image and its projection onto the face space defined by the eigenfaces of Figure 2.



?

PCA Examples: Eigenvoice (1/3)

- Example 5: Eigenvoice in speaker adaptation (PSTL, 2000)
 - Steps
 - Concatenating the regarded parameters for each speaker r to form a huge vector $\mathbf{a}^{(r)}$ (a supervectors)
 - SD HMM model mean parameters (μ)

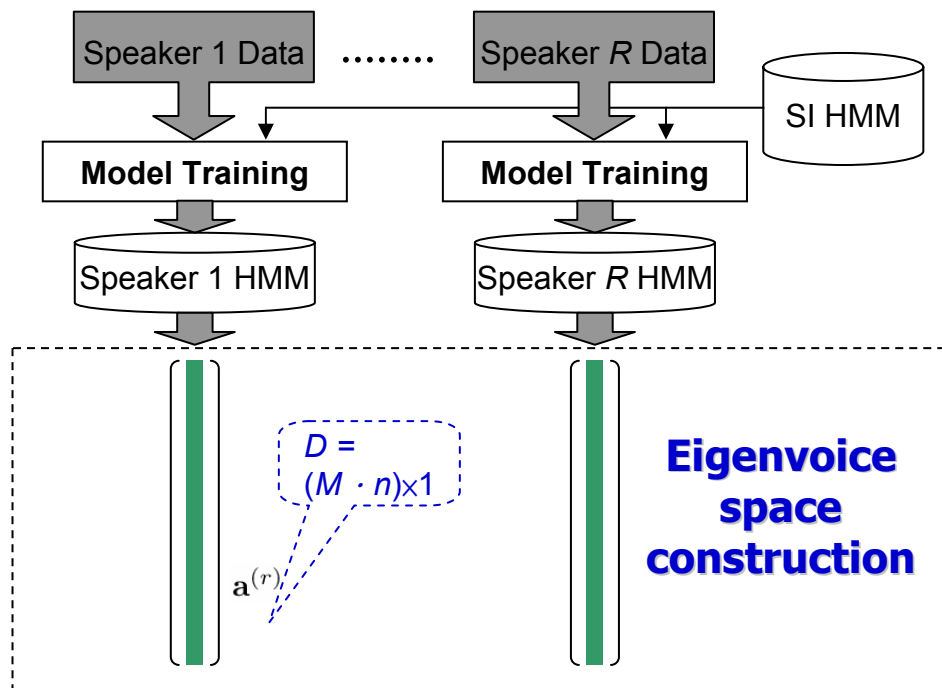

Each new speaker S is represented by a point P in K -space

$$\mathbf{P}_i = \mathbf{e}(0) + w_{i,1} \mathbf{e}(1) + w_{i,2} \mathbf{e}(2) + \dots + w_{i,K} \mathbf{e}(K)$$

SI HMM model

Principal Component Analysis

PCA Examples: Eigenvoice (2/3)

- Example 4: Eigenvoice in speaker adaptation (cont.)

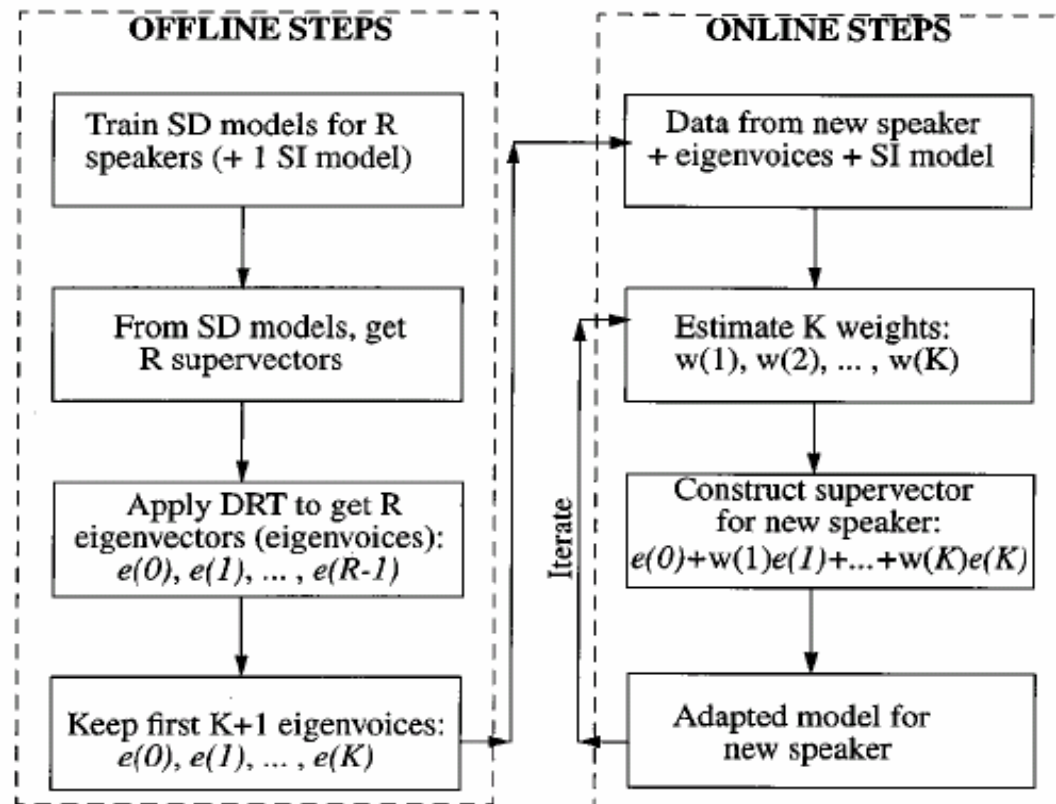

Fig. 1. Block diagram for eigenvoice speaker adaptation

PCA Examples: Eigenvoice (3/3)

- Example 5: Eigenvoice in speaker adaptation (cont.)
 - Dimension 1 (eigenvoice 1):
 - Correlate with pitch or sex
 - Dimension 2 (eigenvoice 2):
 - Correlate with amplitude
 - Dimension 3 (eigenvoice 3):
 - Correlate with second-formant movement

**Note that:
Eigenface performs on feature space
while eigenvoice performs
on model space**

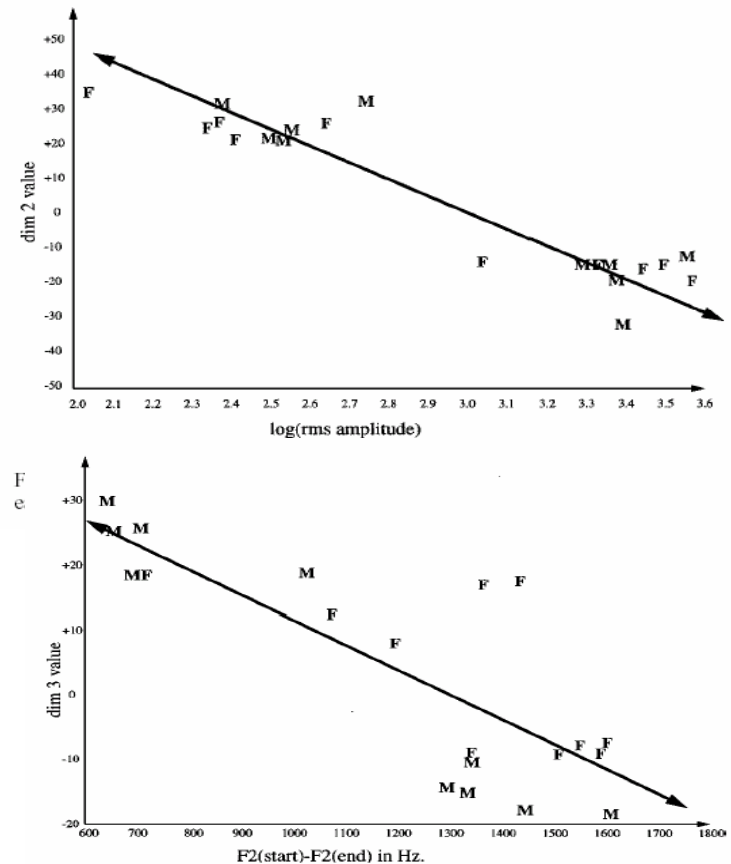

Fig. 4. Dimension 3 versus F2(start)-F2(end) for "U," extreme *M* and *F* in each speaker set

Linear Discriminant Analysis (LDA) (1/2)

- Also called
 - Fisher's Linear Discriminant Analysis, Fisher-Rao Linear Discriminant Analysis
 - Fisher (1936): introduced it for two-class classification
 - Rao (1965): extended it to handle multiple-class classification

Linear Discriminant Analysis (LDA) (2/2)

- Given a set of sample vectors with labeled (class) information, try to find a linear transform \mathbf{W} such that the ratio of **average between-class variation** over **average within-class variation** is maximal

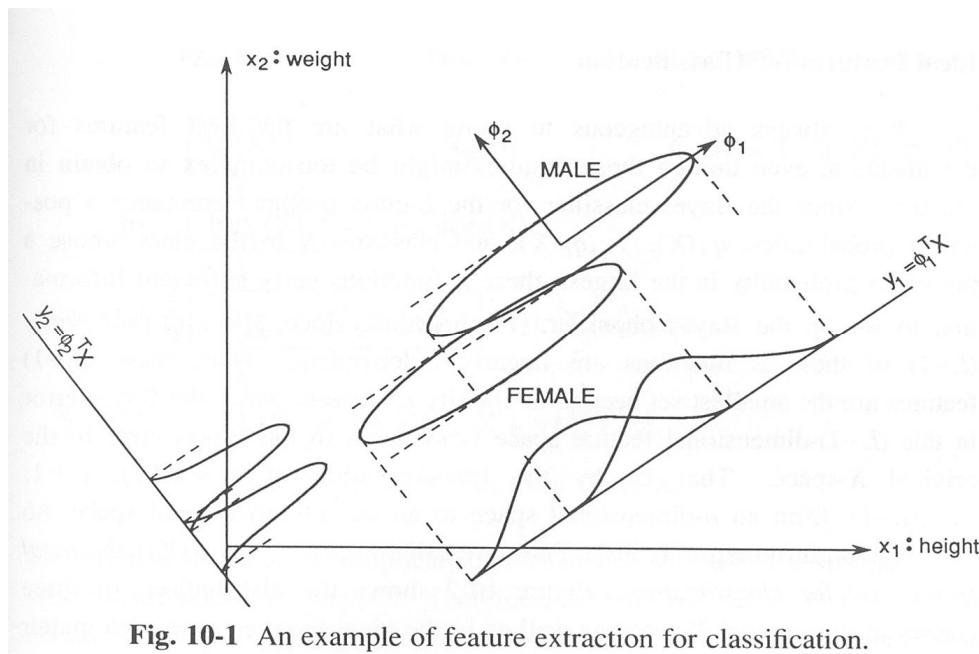

Fig. 10-1 An example of feature extraction for classification.

Within-class distributions are assumed here to be Gaussians
With equal variance in the two-dimensional sample space

LDA Derivations (1/4)

- Suppose there are N sample vectors \mathbf{x}_i with dimensionality n , each of them belongs to one of the J classes $g(\mathbf{x}_i) = j$, $j \in \{1, 2, \dots, J\}$, $g(\cdot)$ is class index

- The sample mean is: $\bar{\mathbf{x}} = \frac{1}{N} \sum_{i=1}^N \mathbf{x}_i$

- The class sample means are: $\bar{\mathbf{x}}_j = \frac{1}{N_j} \sum_{g(\mathbf{x}_i)=j} \mathbf{x}_i$

- The class sample covariances are: $\Sigma_j = \frac{1}{N_j} \sum_{g(\mathbf{x}_i)=j} (\mathbf{x}_i - \bar{\mathbf{x}}_j)(\mathbf{x}_i - \bar{\mathbf{x}}_j)^T$

- The **average within-class variation** before transform

$$\mathbf{S}_w = \frac{1}{N} \sum_j N_j \Sigma_j$$

- The **average between-class variation** before transform

$$\mathbf{S}_b = \frac{1}{N} \sum_j N_j (\bar{\mathbf{x}}_j - \bar{\mathbf{x}})(\bar{\mathbf{x}}_j - \bar{\mathbf{x}})^T$$

LDA Derivations (2/4)

- If the transform $\mathbf{W} = [\mathbf{w}_1 \mathbf{w}_2 \dots \mathbf{w}_m]$ is applied
 - The sample vectors will be $\mathbf{y}_i = \mathbf{W}^T \mathbf{x}_i$
 - The sample mean will be $\bar{\mathbf{y}} = \frac{1}{N} \sum_{i=1}^N \mathbf{W}^T \mathbf{x}_i = \mathbf{W}^T \left(\frac{1}{N} \sum_{i=1}^N \mathbf{x}_i \right) = \mathbf{W}^T \bar{\mathbf{x}}$
 - The class sample means will be $\bar{\mathbf{y}}_j = \frac{1}{N_j} \sum_{g(\mathbf{x}_i)=j} \mathbf{W}^T \mathbf{x}_i = \mathbf{W}^T \bar{\mathbf{x}}_j$
 - The **average within-class variation** will be

$$\begin{aligned} \tilde{\mathbf{S}}_w &= \frac{1}{N} \sum_j N_j \left\{ \frac{1}{N_j} \cdot \sum_{g(\mathbf{x}_i)=j} \left(\mathbf{W}^T \mathbf{x}_i - \frac{1}{N_j} \sum_{g(\mathbf{x}_i)=j} (\mathbf{W}^T \mathbf{x}_i) \right) \left(\mathbf{W}^T \mathbf{x}_i - \frac{1}{N_j} \sum_{g(\mathbf{x}_i)=j} (\mathbf{W}^T \mathbf{x}_i) \right)^T \right\} \\ &= \mathbf{W}^T \left\{ \frac{1}{N} \sum_j N_j \mathbf{\Sigma}_j \right\} \mathbf{W} \\ &= \mathbf{W}^T \mathbf{S}_w \mathbf{W} \end{aligned}$$

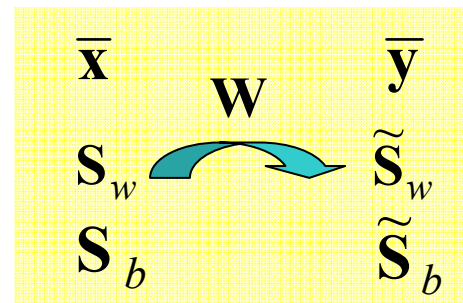

LDA Derivations (3/4)

- If the transform $\mathbf{W} = [\mathbf{w}_1 \mathbf{w}_2 \dots \mathbf{w}_m]$ is applied
 - Similarly, the **average between-class variation** will be

$$\tilde{\mathbf{S}}_b = \mathbf{W}^T \mathbf{S}_b \mathbf{W}$$

- Try to find optimal \mathbf{W} such that the following objective function is maximized

$$J(\mathbf{W}) = \frac{|\tilde{\mathbf{S}}_b|}{|\tilde{\mathbf{S}}_w|} = \frac{|\mathbf{W}^T \mathbf{S}_b \mathbf{W}|}{|\mathbf{W}^T \mathbf{S}_w \mathbf{W}|}$$

- A closed-form solution: the column vectors of an optimal matrix \mathbf{W} are the generalized eigenvectors corresponding to the largest eigenvalues in

$$\mathbf{S}_b \mathbf{w}_i = \lambda_i \mathbf{S}_w \mathbf{w}_i$$

- That is, \mathbf{w}_i 's are the eigenvectors corresponding to the largest eigenvalues of $\mathbf{S}_w^{-1} \mathbf{S}_b$

$$\boxed{\mathbf{S}_w^{-1} \mathbf{S}_b} \mathbf{w}_i = \lambda_i \mathbf{w}_i$$

LDA Derivations (4/4)

- Proof:

$$\because \hat{\mathbf{W}} = \arg \max_{\hat{\mathbf{w}}} J(\mathbf{W}) = \arg \max_{\hat{\mathbf{w}}} \frac{|\tilde{\mathbf{S}}_b|}{|\tilde{\mathbf{S}}_w|} = \arg \max_{\hat{\mathbf{w}}} \frac{|\mathbf{W}^T \mathbf{S}_b \mathbf{W}|}{|\mathbf{W}^T \mathbf{S}_w \mathbf{W}|}$$

determinant

Or, for each column vector \mathbf{w}_i of \mathbf{W} , we want to find that :

$$\text{The quadratic form has optimal solution : } \lambda_i = \frac{\mathbf{w}_i^T \mathbf{S}_b \mathbf{w}_i}{\mathbf{w}_i^T \mathbf{S}_w \mathbf{w}_i}$$

$$\left(\frac{\mathbf{F}}{\mathbf{G}} \right)' = \frac{\mathbf{F}'\mathbf{G} - \mathbf{G}'\mathbf{F}}{\mathbf{G}^2}$$

$$\Rightarrow \frac{\partial \lambda_i}{\partial \mathbf{w}_i} = \frac{2\mathbf{S}_b \mathbf{w}_i (\mathbf{w}_i^T \mathbf{S}_w \mathbf{w}_i) - 2\mathbf{S}_w \mathbf{w}_i (\mathbf{w}_i^T \mathbf{S}_b \mathbf{w}_i)}{(\mathbf{w}_i^T \mathbf{S}_w \mathbf{w}_i)^2} = 0$$

$$\frac{d(\mathbf{x}^T \mathbf{C} \mathbf{x})}{d\mathbf{x}} = (\mathbf{C} + \mathbf{C}^T) \mathbf{x}$$

$$\Rightarrow \frac{\mathbf{S}_b \mathbf{w}_i (\mathbf{w}_i^T \mathbf{S}_w \mathbf{w}_i)}{(\mathbf{w}_i^T \mathbf{S}_w \mathbf{w}_i)^2} - \frac{\mathbf{S}_w \mathbf{w}_i (\mathbf{w}_i^T \mathbf{S}_b \mathbf{w}_i)}{(\mathbf{w}_i^T \mathbf{S}_w \mathbf{w}_i)^2} = 0$$

$$\frac{\mathbf{S}_b \mathbf{w}_i}{\mathbf{w}_i^T \mathbf{S}_w \mathbf{w}_i} - \frac{\mathbf{S}_w \mathbf{w}_i}{\mathbf{w}_i^T \mathbf{S}_w \mathbf{w}_i} \lambda_i = 0 \quad \left(\because \lambda_i = \frac{\mathbf{w}_i^T \mathbf{S}_b \mathbf{w}_i}{\mathbf{w}_i^T \mathbf{S}_w \mathbf{w}_i} \right)$$

$$\Rightarrow \mathbf{S}_b \mathbf{w}_i - \lambda_i \mathbf{S}_w \mathbf{w}_i = 0 \Rightarrow \mathbf{S}_b \mathbf{w}_i = \lambda_i \mathbf{S}_w \mathbf{w}_i$$

$$\Rightarrow \mathbf{S}_w^{-1} \mathbf{S}_b \mathbf{w}_i = \lambda_i \mathbf{w}_i$$

LDA Examples: Feature Transformation (1/2)

- Example 1: Experiments on Speech Signal Processing

Covariance Matrix of the 18-Mel-filter-bank vectors

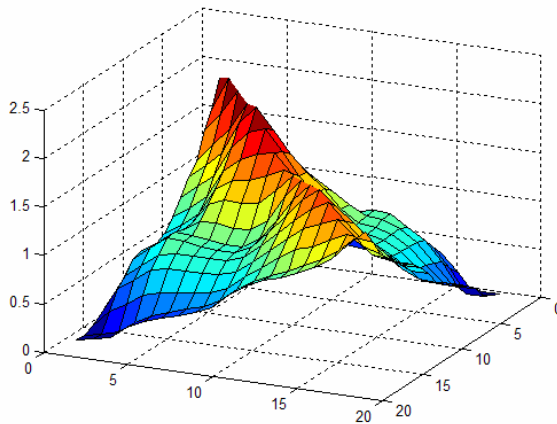

Calculated using Year-99's 5471 files

$$\Sigma = \frac{1}{N} \sum_{\mathbf{x}_i} (\mathbf{x}_i - \bar{\mathbf{x}})(\mathbf{x}_i - \bar{\mathbf{x}})^T$$

Covariance Matrix of the 18-cepstral vectors

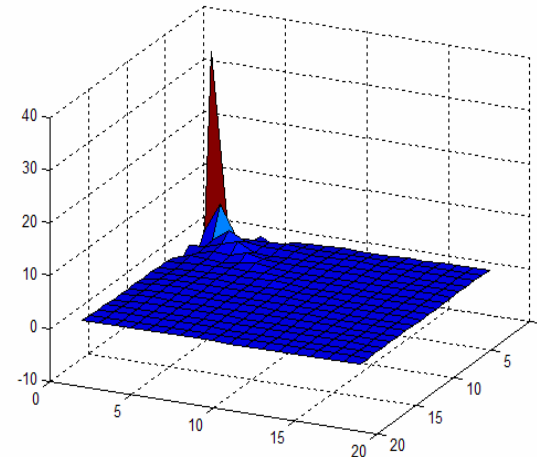

Calculated using Year-99's 5471 files

$$\Sigma' = \frac{1}{N} \sum_{\mathbf{y}_i} (\mathbf{y}_i - \bar{\mathbf{y}})(\mathbf{y}_i - \bar{\mathbf{y}})^T$$

After Cosine Transform

LDA Examples: Feature Transformation (2/2)

- Example1: Experiments on Speech Signal Processing (cont.)

Covariance Matrix of the 18-PCA-cepstral vectors Covariance Matrix of the 18-LDA-cepstral vectors

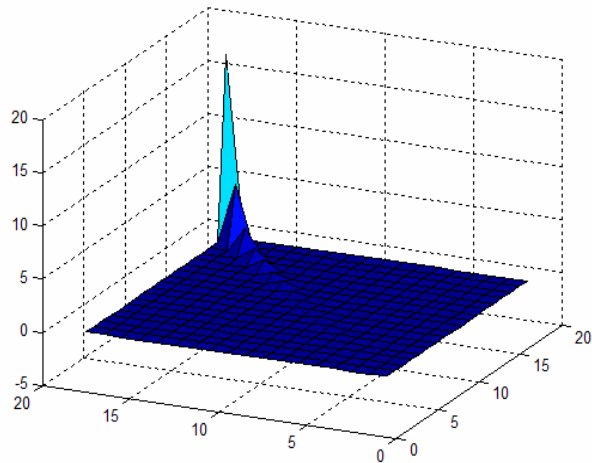

Calculated using Year-99's 5471 files

After PCA Transform

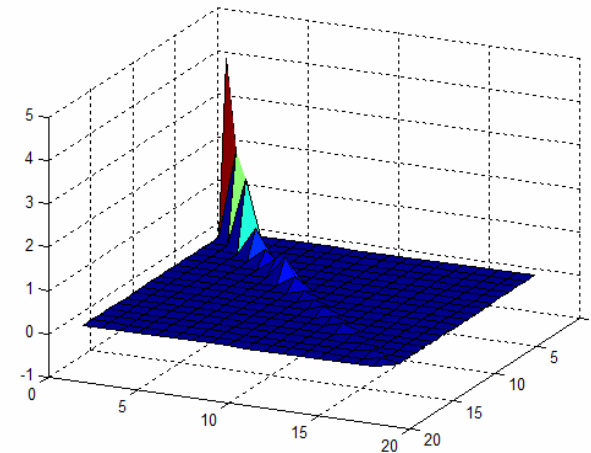

Calculated using Year-99's 5471 files

After LDA Transform

	Character Error Rate	
	TC	WG
MFCC	26.32	22.71
LDA-1	23.12	20.17
LDA-2	23.11	20.11

PCA vs. LDA (1/2)

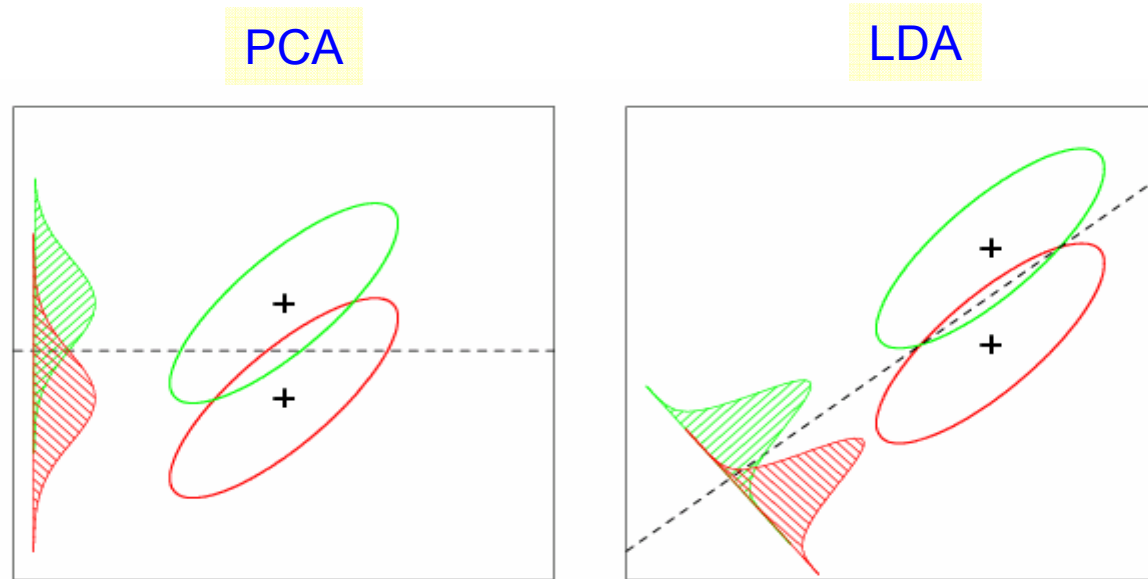

Figure 4.9: *Although the line joining the centroids defines the direction of greatest centroid spread, the projected data overlap because of the covariance (left panel). The discriminant direction minimizes this overlap for Gaussian data (right panel).*

Heteroscedastic Discriminant Analysis (HDA)

- HDA: Heteroscedastic Discriminant Analysis
- The difference in the projections obtained from LDA and HDA for 2-class case

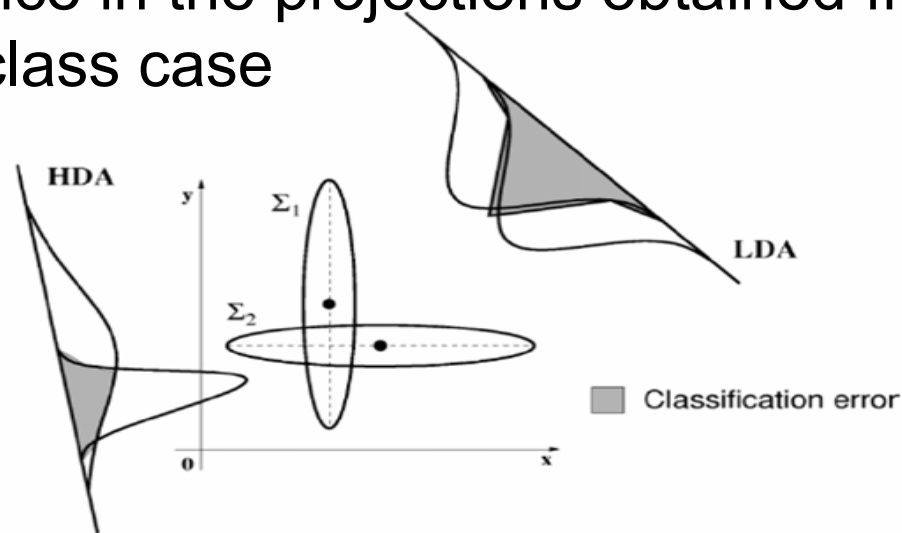

Fig. 1. Difference between LDA and HDA.

- Clearly, the HDA provides a much lower classification error than LDA theoretically
 - However, most statistical modeling assume data samples are Gaussian and have **diagonal** covariance matrices

HW-3 Feature Transformation (1/4)

- Given two data sets ([MaleData](#), [FemaleData](#)) in which each row is a sample with 39 features, please perform the following operations:
 1. Merge these two data sets and find/plot the covariance matrix for the merged data set.
 2. Apply PCA and LDA transformations to the merged data set, respectively. Also, find/plot the covariance matrices for transformations, respectively. Describe the phenomena that you have observed.
 3. Use the first two principal components of PCA as well as the first two eigenvectors of LDA to represent the merged data set. Selectively plot portions of samples from MaleData and FemaleData, respectively. Describe the phenomena that you have observed.

HW-3 Feature Transformation (2/4)

6.42713	6.63794	7.06637	7.88889	8.28665	9.13144	9.15820	9.02314	9.06447	9.54492	9.64417	9.39750	9.54539	9.66743	9.96106	10.31767	10.27543	10.35846
6.60918	6.68978	7.54557	7.51135	8.41962	9.19990	8.97876	8.84358	9.17819	9.38652	9.18760	9.15817	9.67501	9.86622	9.86302	10.19308	10.28680	10.20568
6.41962	7.13809	7.66789	7.36502	8.29559	9.72309	9.25206	8.89061	9.23610	9.54463	9.61080	9.90144	9.84137	9.87632	10.17686	10.10185	10.39783	10.18437
6.86355	7.00569	7.17471	8.15614	8.71617	9.41083	9.44752	9.21923	9.35536	9.64052	9.41545	9.77079	9.81874	9.72490	10.12627	10.20459	10.63373	10.43855
7.22548	6.75456	7.23428	7.96735	8.45112	9.24918	9.33575	9.05005	9.58763	9.98788	9.81818	9.76883	9.92221	9.84083	10.19516	10.26957	10.47222	10.41586
7.37737	6.37170	7.55167	7.51087	8.95966	9.18450	8.84421	8.89329	9.70726	10.11613	9.69935	9.83229	9.77153	9.98695	10.22368	10.27461	10.28110	10.23929
6.31627	7.09834	7.44018	7.94135	8.97552	9.09170	9.58235	9.07187	9.48562	9.95253	9.47215	9.50158	9.88541	10.03101	10.17139	10.19946	10.51533	10.47495
7.32665	7.13843	7.90410	7.89386	8.75346	9.18233	10.11025	9.50357	9.42500	9.86274	9.40006	9.87786	9.84763	10.17598	10.02787	10.44857	10.36439	10.15492
6.87833	6.38132	7.82116	7.91663	8.70769	9.36655	9.66250	9.53536	9.85095	9.74988	10.11805	9.96693	9.84836	9.97311	10.06228	10.27342	10.59408	10.49595
6.85021	6.65767	7.23630	8.04771	8.48361	9.55667	9.95110	9.61122	9.05134	9.69155	9.96958	9.62920	9.90382	9.78647	10.36104	10.26381	10.40579	10.29332
7.22140	7.02353	7.77372	8.44543	9.04546	9.48666	9.63974	9.36783	9.19456	10.16187	9.64667	10.10419	9.88623	9.73151	9.99944	10.25832	10.48060	10.30917
7.04571	7.34592	8.25410	8.51151	8.84546	8.73990	9.55656	9.70503	9.36017	9.99317	9.50287	9.90498	10.22401	10.21169	9.99052	10.15059	10.43741	10.29127
6.40109	6.62064	7.85343	8.41806	8.80033	8.95982	9.85976	9.72723	9.83326	9.75391	9.46737	9.78288	10.33103	10.25947	10.10942	10.33977	10.69843	10.61361
7.03983	6.81402	8.06266	8.49128	9.09858	9.49709	9.50981	9.40213	9.62871	9.36644	9.69002	9.93724	10.11084	10.38737	10.29060	10.29727	10.65062	10.87061
7.48447	7.44521	8.31400	9.00737	8.76473	9.58358	9.73854	9.70255	10.06008	10.47637	9.98790	9.78771	10.16327	10.27081	10.72976	10.63497	10.65275	11.12336
8.95152	10.14082	11.47406	11.95361	11.70543	12.49259	11.92901	10.78543	10.28769	10.54797	10.36536	10.82128	12.31664	12.38622	11.08099	10.52101	10.49685	10.82546
9.28539	10.41168	12.07715	12.69397	12.28251	13.02032	12.16224	10.87808	10.60156	10.51851	10.51198	11.84690	13.09367	13.19682	11.56034	10.36879	10.73642	11.23687
9.25284	10.39935	12.28775	13.09387	12.33200	13.04389	12.22348	11.28230	10.57541	10.58302	10.49196	11.57102	12.65899	12.78191	11.54582	10.47776	11.17009	12.07101
9.48814	10.57697	12.14462	13.05838	12.27252	12.92096	12.01746	11.10978	10.71202	10.45176	10.20901	11.49229	12.56191	12.74920	11.53024	10.50136	11.48792	12.38682
9.24510	10.53409	12.10514	12.99560	12.26131	12.82944	11.99671	11.09576	10.60223	10.62066	10.69532	11.52727	12.55299	12.58644	11.41030	10.98138	11.54383	12.39193
9.37856	10.56379	12.15502	13.03582	12.33346	12.79591	11.99477	11.25890	10.59781	10.41142	10.29753	11.61179	12.76901	12.82854	11.53489	10.26693	11.59377	12.46711
9.10574	10.36238	12.10913	13.03047	12.30543	12.79777	11.82454	11.11023	9.95303	10.23726	10.21457	11.65016	12.75013	12.79919	11.44790	10.15221	11.34570	12.17819
9.25286	10.39592	12.10761	13.02590	12.34146	12.79751	11.87436	11.27570	10.28222	10.08590	10.16289	11.58145	12.79790	12.92117	11.85415	11.04553	11.50033	12.03395
9.37944	10.22634	11.99594	12.97796	12.20640	12.68950	11.63688	10.97845	10.14909	10.25551	10.07726	11.59147	12.75670	12.87878	11.58397	10.53411	11.23498	11.82416
9.24735	10.33095	11.90092	12.90967	12.19729	12.57357	11.55529	10.94830	10.37612	9.99572	10.02343	11.44121	12.66732	12.85391	11.41223	10.18042	11.05130	11.66860
9.35116	10.40006	11.91490	12.92593	12.26836	12.59967	11.73072	11.07363	10.42829	10.38190	10.02016	11.40167	12.67601	12.85032	11.48816	10.23896	11.00952	11.80363
8.85565	10.22952	11.97470	12.93747	12.32025	12.69687	11.91195	11.12610	10.04652	9.74522	9.84040	11.60561	12.81711	12.93019	11.65117	9.94210	11.10972	11.99067
9.06311	10.24851	11.99336	12.94507	12.31958	12.76722	11.92754	11.29551	10.84976	10.67713	10.83308	11.72299	12.74011	12.89174	11.78875	10.96543	11.26600	11.78640
9.09109	10.14237	11.89207	12.92688	12.24762	12.85326	11.95840	11.03245	10.29068	10.24957	10.27929	11.71948	12.71321	12.68492	11.41932	10.22840	10.86876	11.48627
8.86112	10.11202	11.76434	12.84603	12.17904	13.02281	12.22743	11.03697	10.28548	10.17738	10.02944	11.64224	12.81149	12.83681	11.66230	10.22197	11.06236	11.69995
8.95651	10.17607	11.70941	12.79840	12.22853	13.30465	12.69674	11.08070	10.19255	10.17787	10.25474	11.54506	12.74126	12.82745	11.66595	10.67840	11.28033	11.46947
8.95184	10.11466	11.58894	12.70559	12.22427	13.43013	12.99500	11.03695	10.67592	10.59266	10.27218	11.53677	12.75268	12.84525	11.55395	10.62605	11.29321	11.76728
8.93481	9.98079	11.53426	12.61443	12.18141	13.39686	13.12180	11.24372	11.18761	11.21561	10.94448	11.49001	12.90905	12.92089	11.51464	11.14149	11.56695	11.34264
8.72390	9.95325	11.41650	12.50804	11.93665	13.10813	13.55141	11.87676	10.84982	10.72457	10.66934	11.68744	12.83971	12.57063	10.68780	10.36828	11.23385	11.65968
8.86731	9.81090	11.35759	12.46365	11.73738	12.92556	13.85868	12.05668	11.03708	10.91234	11.01318	11.93650	12.50144	12.07413	10.67163	10.11630	10.95211	11.41643
8.80004	9.90337	11.28811	12.37457	11.65101	12.55219	13.91458	12.54423	11.45110	11.56509	11.62036	11.89225	11.84936	11.56170	10.11295	10.03426	10.44886	11.15139
8.57503	9.97730	11.39499	12.22883	11.38133	12.14903	13.53391	12.64970	11.92921	12.17885	11.20951	11.04259	10.90964	11.08990	10.09882	9.93701	10.45472	10.65229
8.75854	9.98532	11.42928	12.01617	10.91319	11.97503	13.51339	12.86567	12.40181	12.14269	10.32589	10.47594	10.34628	10.29207	9.72180	9.70791	10.20271	10.23657
8.51064	9.97845	11.34774	11.85436	10.77862	11.96920	13.59716	13.01747	12.50466	11.12553	10.26017	10.24660	9.95529	10.16539	9.91504	9.86165	10.05572	10.10832
8.75284	9.97322	11.25107	11.53580	10.56970	11.97240	13.64676	13.00659	12.59076	11.15314	10.01281	10.27642	10.30719	9.83591	9.89535	9.69011	10.18799	10.07413
8.69811	9.91990	11.20998	11.35521	10.37719	11.88766	13.57117	12.64817	12.11702	11.51724	10.04957	10.00606	9.78021	10.03180	10.04367	9.96540	10.08658	9.99362
8.68049	9.92636	11.23110	11.61208	10.79860	12.07838	13.56636	12.68811	12.66671	12.70132	10.51101	10.28009	9.94354	10.01544	10.24593	10.05090	10.04164	10.39702
8.59695	9.95619	11.23503	12.34665	11.84855	12.56838	13.74129	12.87108	12.25929	12.86958	11.52864	11.20175	11.33119	11.15635	10.20941	10.03565	10.47241	11.73222
9.21813	10.07835	11.23133	12.52400	12.18068	12.65421	14.01153	13.15049	11.75339	11.69041	11.44919	11.91691	12.59050	12.06584	10.28150	10.16722	10.63046	11.66016
9.45242	9.83172	10.99231	12.37461	12.37894	12.67601	14.08033	13.31300	11.63499	11.57846	11.20036	11.72327	12.59090	12.73404	11.21351	10.89487	11.06791	11.73133
9.16915	9.38694	10.78770	12.23222	12.46109	12.79289	14.14283	13.42151	11.68986	11.50380	11.17019	11.80490	12.45519	13.22823	11.71481	10.32775	10.48164	11.30554

HW-3 Feature Transformation (3/4)

- Plot Covariance Matrix

```
CoVar=[
    3.0    0.5    0.4;
    0.9    6.3    0.2;
    0.4    0.4    4.2;
];
colormap('default');
surf(CoVar);
```

- Eigen Decomposition

```
BE=[
    3.0    3.5    1.4;
    1.9    6.3    2.2;
    2.4    0.4    4.2;
];
WI=[
    4.0    4.1    2.1;
    2.9    8.7    3.5;
    4.4    3.2    4.3;
];
```

```
%LDA
IWI=inv(WI);
A=IWI*BE;
%PCA
A=BE+WI; % why ?? ( Prove it! )

[V,D]=eig(A);
[V,D]=eigs(A,3);

fid=fopen('Basis','w');
for i=1:3 % feature vector length
    for j=1:3 % basis number
        fprintf(fid,'%10.10f ',V(i,j));
    end
    fprintf(fid,'\n');
end
fclose(fid);
```

HW-3 Feature Transformation (4/4)

- Examples

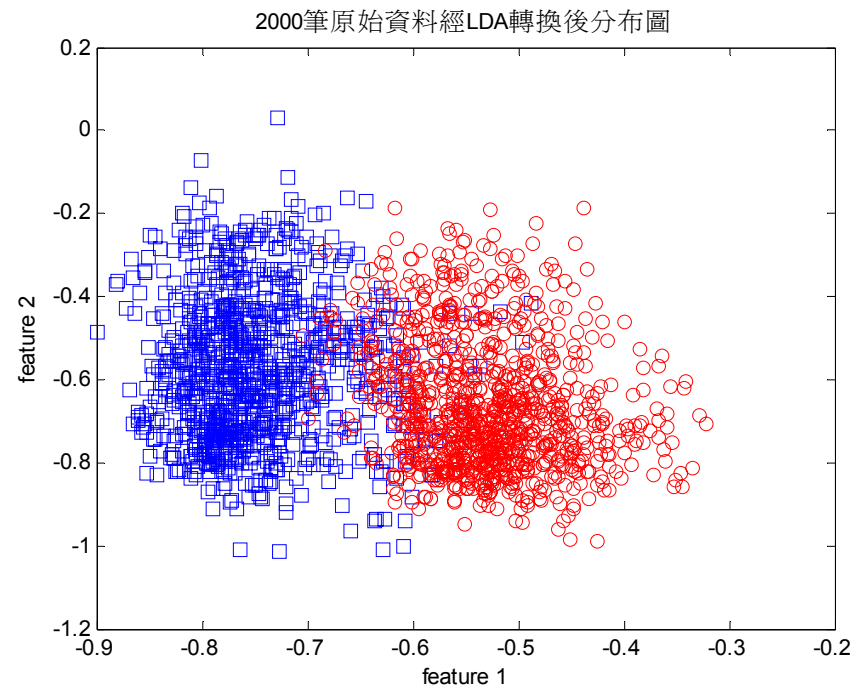
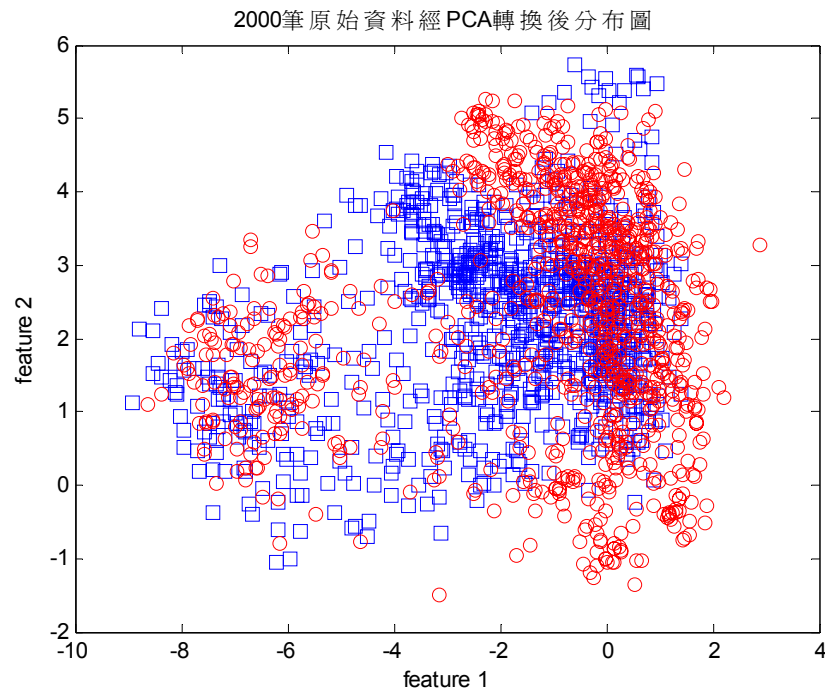

Latent Semantic Analysis (LSA) (1/7)

- Also called **Latent Semantic Indexing (LSI)**, **Latent Semantic Mapping (LSM)**
- A technique originally proposed for Information Retrieval (IR), which projects queries and docs into a space with “latent” semantic dimensions

- **Co-occurring terms are projected onto the same dimensions**

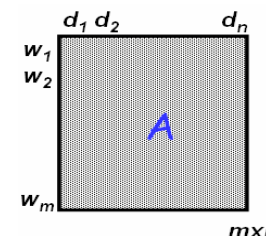

- In the latent semantic space (with fewer dimensions), a query and doc can have high cosine similarity even if they do not share any terms
 - Dimensions of the reduced space correspond to the axes of greatest variation
 - **Closely related to Principal Component Analysis (PCA)**

LSA (2/7)

- Dimension Reduction and Feature Extraction

- PCA

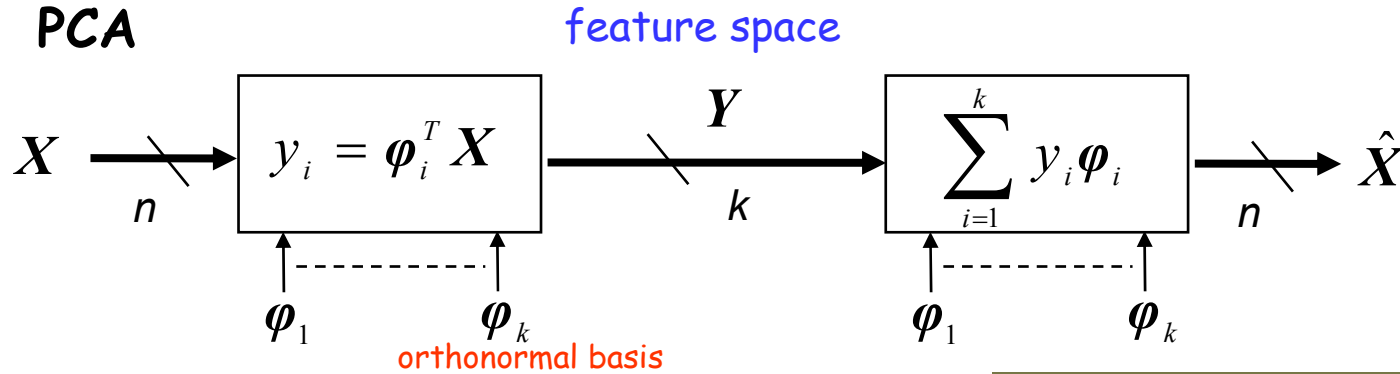

- SVD (in LSA)

$$\min \|\hat{X} - X\|^2 \text{ for a given } k$$

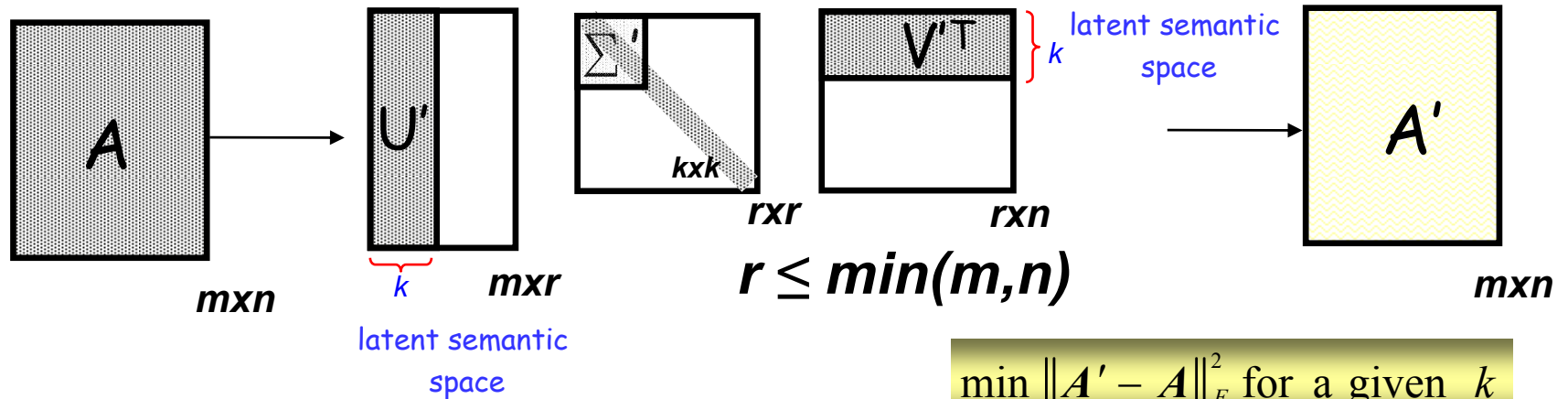

$$\min \|A' - A\|_F^2 \text{ for a given } k$$

LSA (3/7)

- Singular Value Decomposition (SVD) used for the word-document matrix
 - A least-squares method for dimension reduction

	Term 1	Term 2	Term 3	Term 4
Query	user	interface		
Document 1	user	interface	HCI	interaction
Document 2			HCI	interaction

Projection of a Vector \mathbf{x} :

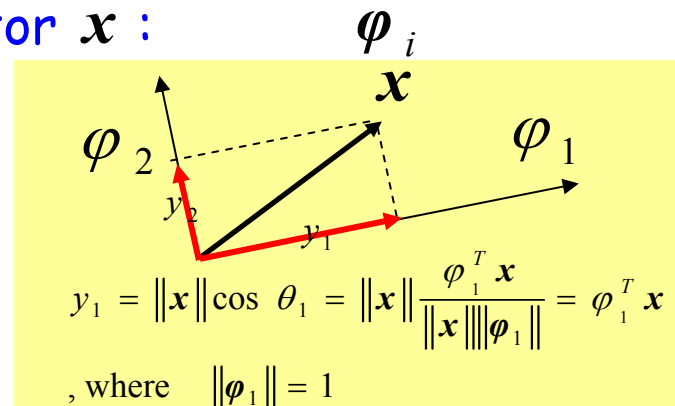

LSA (4/7)

- Frameworks to circumvent vocabulary mismatch

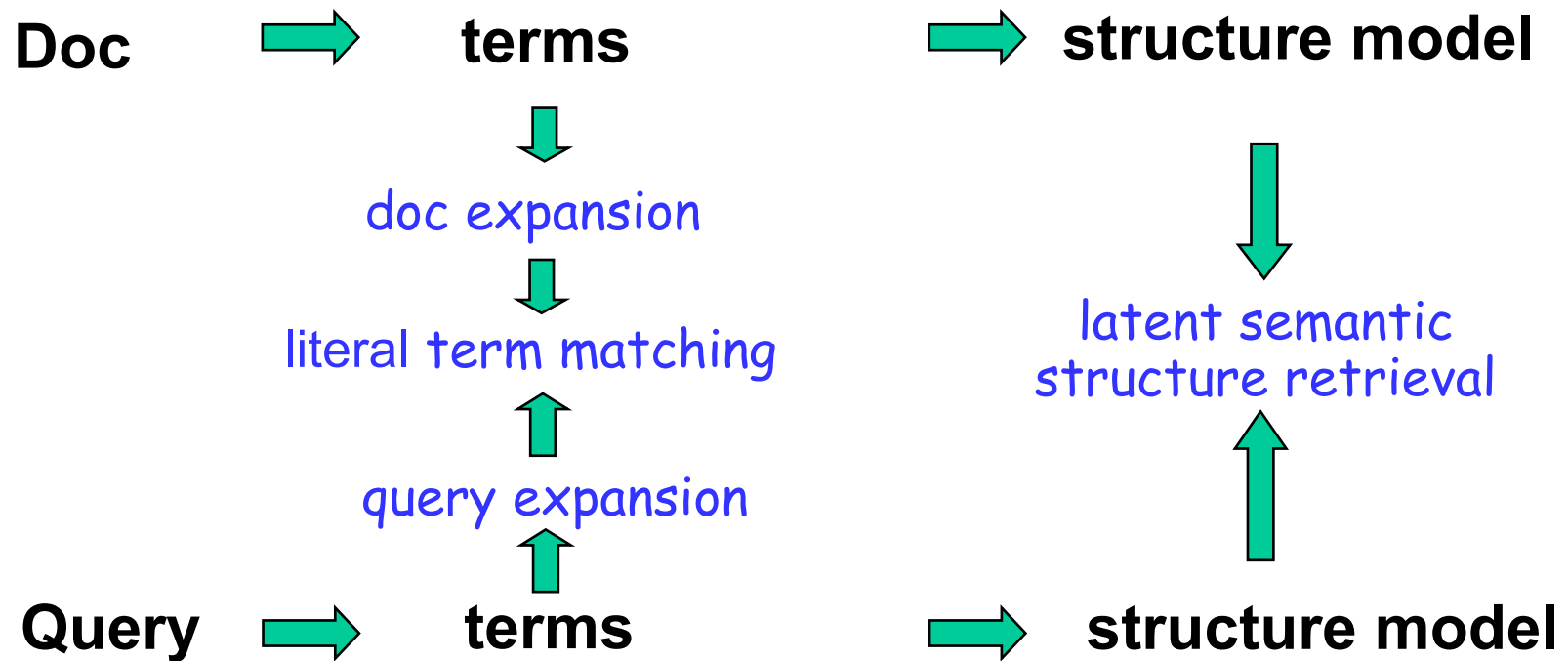

LSA (5/7)

Titles

- c1: *Human machine interface for Lab ABC computer applications*
 c2: *A survey of user opinion of computer system response time*
 c3: *The EPS user interface management system*
 c4: *System and human system engineering testing of EPS*
 c5: *Relation of user-perceived response time to error measurement*
 m1: *The generation of random, binary, unordered trees*
 m2: *The intersection graph of paths in trees*
 m3: *Graph minors IV: Widths of trees and well-quasi-ordering*
 m4: *Graph minors: A survey*

Terms

Documents

	c1	c2	c3	c4	c5	m1	m2	m3	m4
<i>human</i>	1	0	0	1	0	0	0	0	0
<i>interface</i>	1	0	1	0	0	0	0	0	0
<i>computer</i>	1	1	0	0	0	0	0	0	0
<i>user</i>	0	1	1	0	1	0	0	0	0
<i>system</i>	0	1	1	2	0	0	0	0	0
<i>response</i>	0	1	0	0	1	0	0	0	0
<i>time</i>	0	1	0	0	1	0	0	0	0
<i>EPS</i>	0	0	1	1	0	0	0	0	0
<i>survey</i>	0	1	0	0	0	0	0	0	1
<i>trees</i>	0	0	0	0	0	1	1	1	0
<i>graph</i>	0	0	0	0	0	0	1	1	1
<i>minors</i>	0	0	0	0	0	0	0	1	1

LSA (6/7)

2-D Plot of Terms and Docs from Example

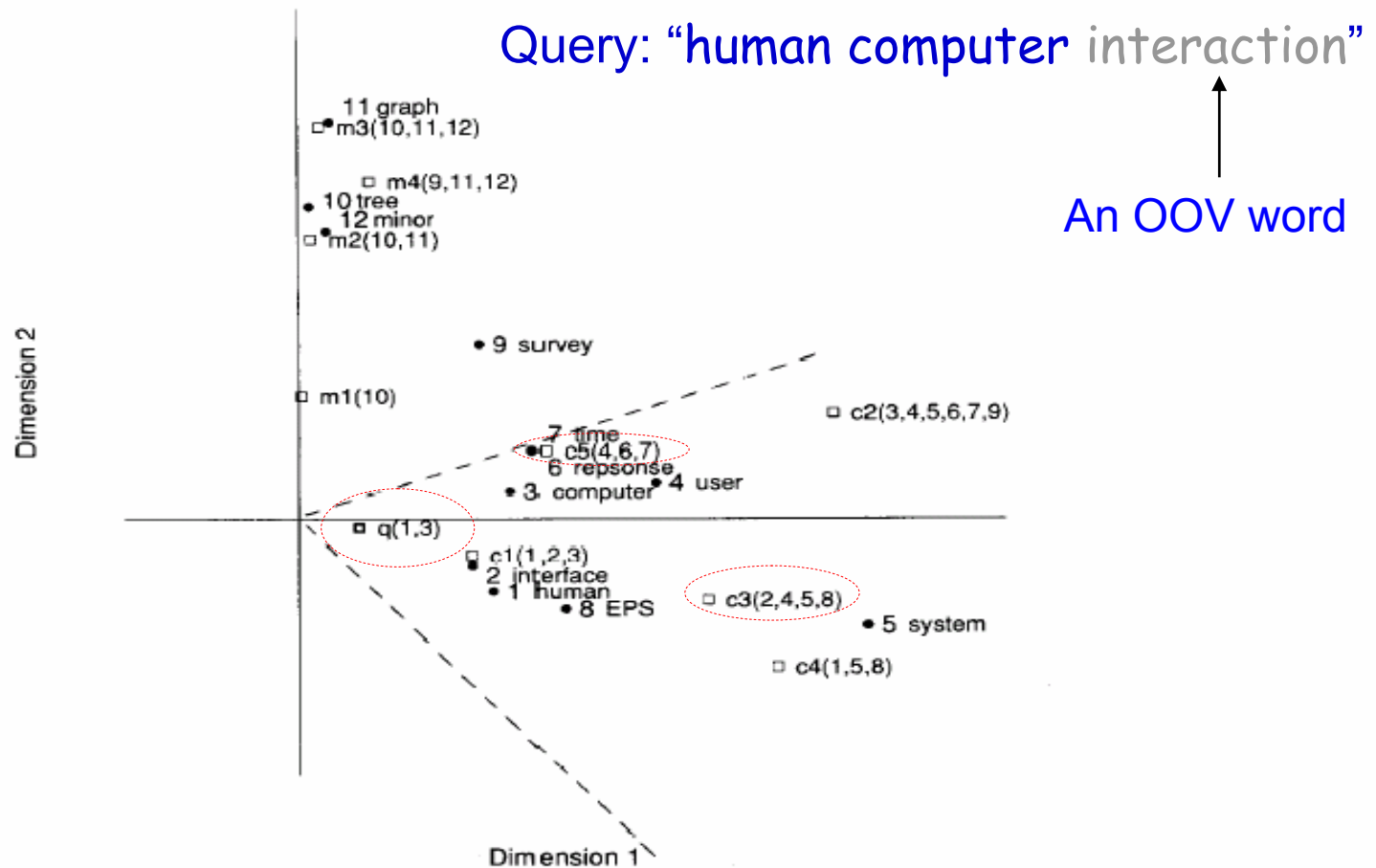
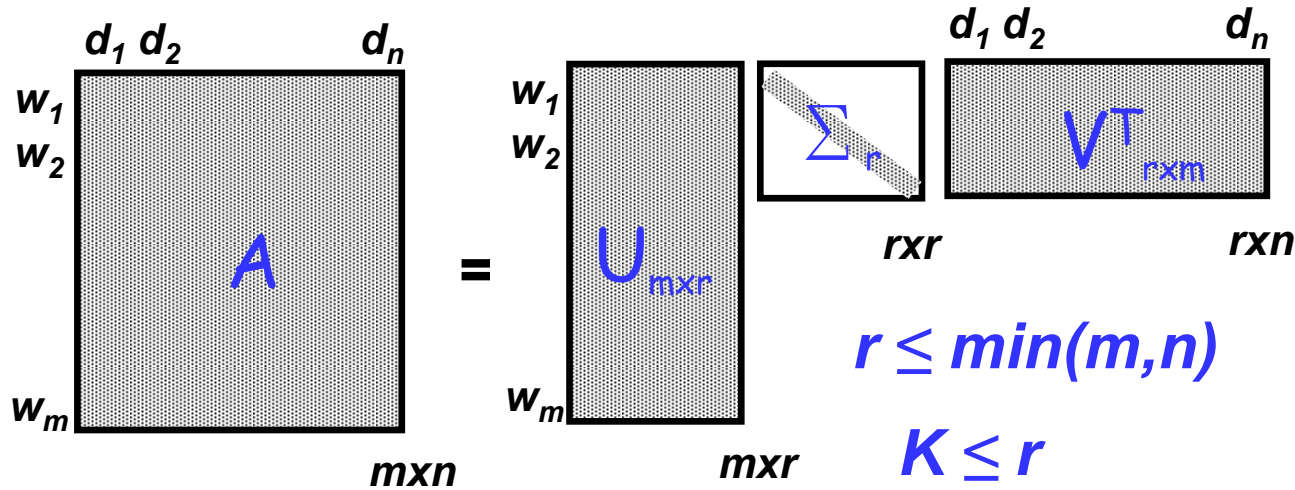

FIG. 1. A two-dimensional plot of 12 Terms and 9 Documents from the same TM set. Terms are represented by filled circles. Documents are shown as open squares, and component terms are indicated parenthetically. The query ("human computer interaction") is represented as a pseudo-document at point q . Axes are scaled for Document-Document or Term-Term comparisons. The dotted cone represents the region whose points are within a cosine of .9 from the query q . All documents about human-computer (c1-c5) are "near" the query (i.e., within this cone), but none of the graph theory documents (m1-m4) are nearby. In this reduced space, even documents c3 and c5 which share no terms with the query are near it.

LSA (7/7)

- Singular Value Decomposition (SVD)



Row $A \in R^n$
 Col $A \in R^m$
 Both U and V has orthonormal column vectors

$$U^T U = I_{r \times r}$$

$$V^T V = I_{r \times r}$$

$$\|A\|_F^2 \geq \|A'\|_F^2$$

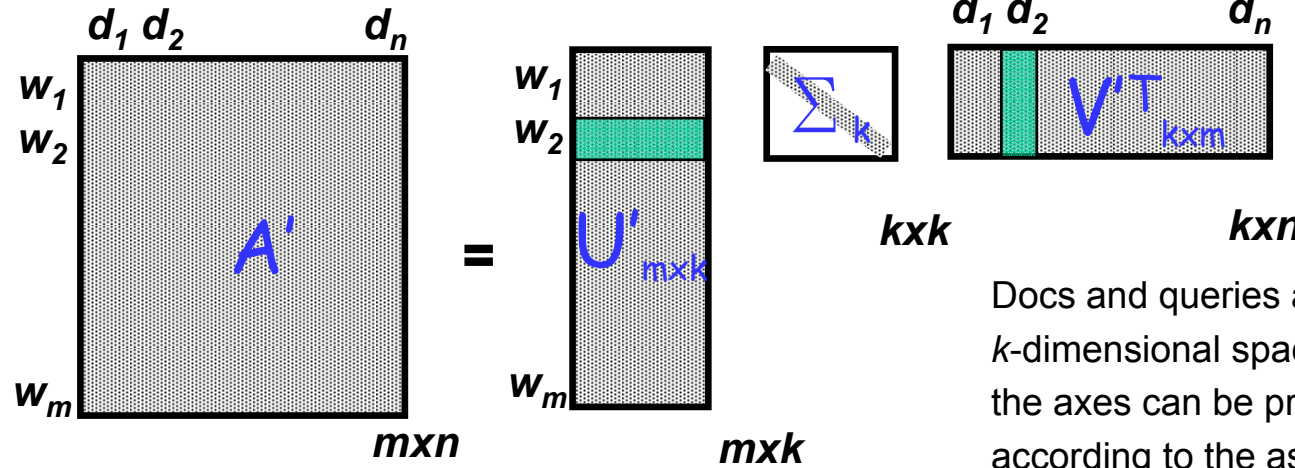

$$\|A\|_F^2 = \sum_{i=1}^m \sum_{j=1}^n a_{ij}^2$$

Docs and queries are represented in a k -dimensional space. The quantities of the axes can be properly weighted according to the associated diagonal values of Σ_k

LSA Derivations (1/7)

- Singular Value Decomposition (SVD)

- $A^T A$ is symmetric $n \times n$ matrix

- All eigenvalues λ_j are nonnegative real numbers

$$\lambda_1 \geq \lambda_2 \geq \dots \geq \lambda_n \geq 0 \quad \Sigma^2 = \text{diag}(\lambda_1, \lambda_1, \dots, \lambda_n)$$

- All eigenvectors v_j are orthonormal ($\in R^n$)

$$V_{n \times n} = [v_1 v_2 \dots v_n] \quad v_j^T v_j = 1 \quad (V^T V = I_{n \times n})$$

sigma $\sigma_j = \sqrt{\lambda_j}, j = 1, \dots, n$

- Define **singular values**:

- As the square roots of the eigenvalues of $A^T A$

- As the lengths of the vectors Av_1, Av_2, \dots, Av_n

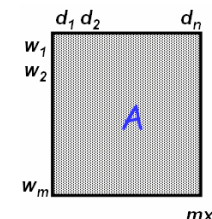

For $\lambda_i \neq 0, i=1, \dots, r,$
 $\{Av_1, Av_2, \dots, Av_r\}$ is an
 orthogonal basis of Col A

$$\sigma_1 = \|Av_1\|$$

$$\sigma_2 = \|Av_2\|$$

.....

$$\|Av_i\|^2 = v_i^T A^T A v_i = v_i^T \lambda_i v_i = \lambda_i$$

$$\Rightarrow \|Av_i\| = \sigma_i$$

LSA Derivations (2/7)

- $\{Av_1, Av_2, \dots, Av_r\}$ is an **orthogonal** basis of **Col A**

$$Av_i \bullet Av_j = (Av_i)^T Av_j = v_i^T A^T Av_j = \lambda_j v_i^T v_j = 0$$

- Suppose that A (or $A^T A$) has rank $r \leq n$

$$\lambda_1 \geq \lambda_2 \geq \dots \geq \lambda_r > 0, \quad \lambda_{r+1} = \lambda_{r+2} = \dots = \lambda_n = 0$$

- Define an **orthonormal** basis $\{u_1, u_2, \dots, u_r\}$ for Col A

$$u_i = \frac{1}{\|Av_i\|} Av_i = \frac{1}{\sigma_i} Av_i \Rightarrow \sigma_i u_i = Av_i$$

u_i also an
orthonormal matrix
($m \times r$)

$$\Rightarrow [u_1 \ u_2 \ \dots \ u_r] \Sigma_r = A [v_1 \ v_2 \ \dots \ v_r]$$

V : an orthonormal matrix ($n \times r$)

Known in advance

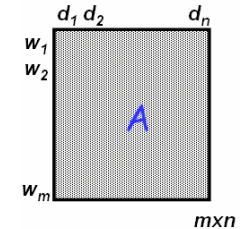

- Extend to an orthonormal basis $\{u_1, u_2, \dots, u_m\}$ of R^m

$$\Rightarrow [u_1 \ u_2 \ \dots \ u_r \ \dots \ u_m] \Sigma = A [v_1 \ v_2 \ \dots \ v_r \ \dots \ v_n]$$

$$\Rightarrow U \Sigma = AV \Rightarrow U \Sigma V^T = A \underbrace{V V^T}$$

$$\Rightarrow A = U \Sigma V^T \quad \Sigma_{m \times n} = \begin{pmatrix} \Sigma_r & \mathbf{0}_{r \times (n-r)} \\ \mathbf{0}_{(m-r) \times r} & \mathbf{0}_{(m-r) \times (n-r)} \end{pmatrix} \quad I_{n \times n} \quad ?$$

$$\|A\|_F^2 = \sum_{i=1}^m \sum_{j=1}^n a_{ij}^2$$

$$\|A\|_F^2 = \sigma_1^2 + \sigma_2^2 + \dots + \sigma_r^2 \quad ?$$

LSA Derivations (3/7)

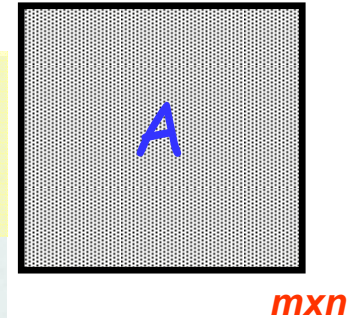
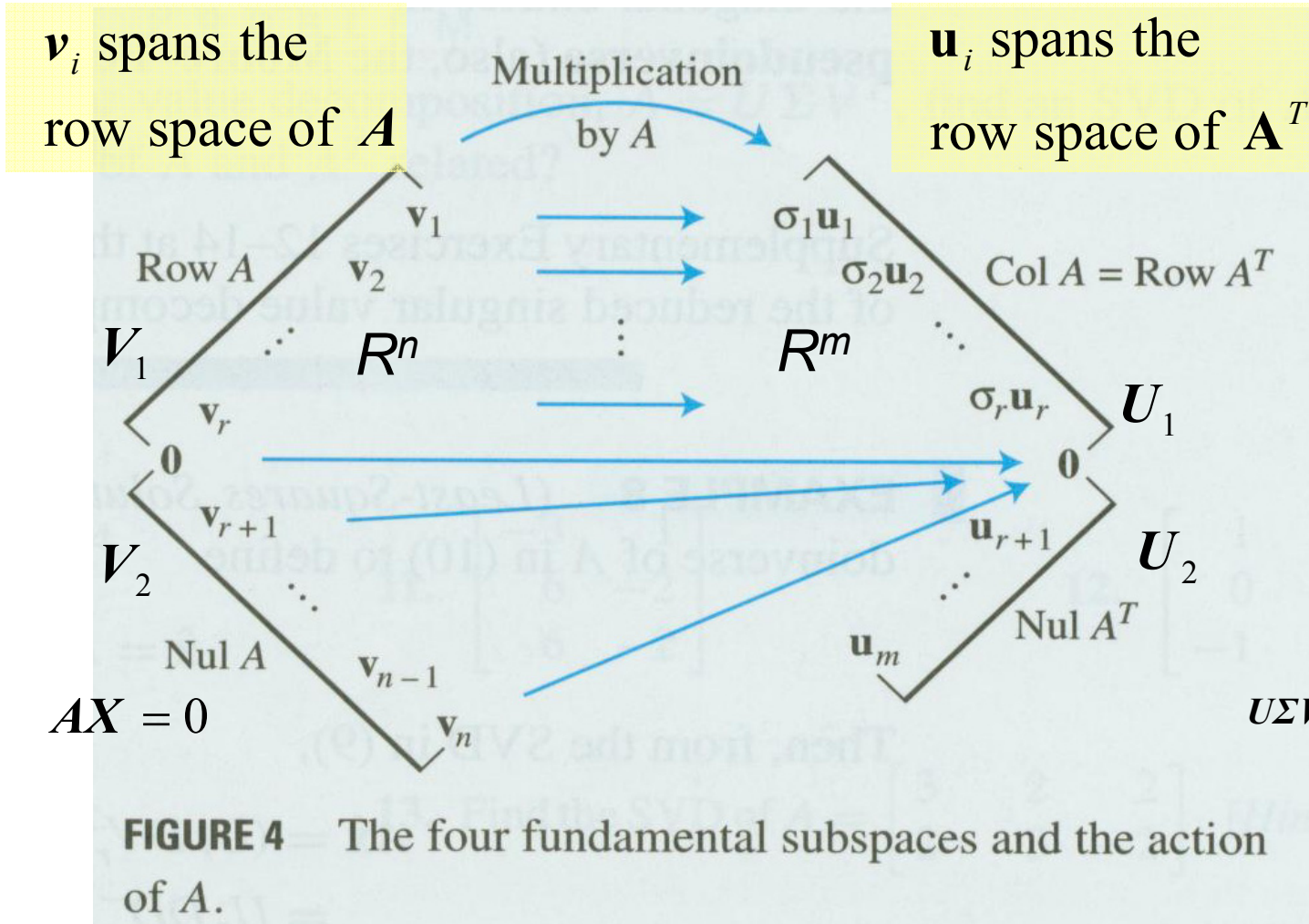

$$\begin{aligned}
 U \Sigma V^T &= \begin{pmatrix} U_1 & U_2 \end{pmatrix} \begin{pmatrix} \Sigma_1 & 0 \\ 0 & 0 \end{pmatrix} \begin{pmatrix} V_1^T \\ V_2^T \end{pmatrix} \\
 &= U_1 \Sigma_1 V_1^T \\
 &= A V_1 V_1^T \quad \boxed{U \Sigma = A V} \\
 &= A
 \end{aligned}$$

LSA Derivations (4/7)

- Additional Explanations

- Each row of U is related to the projection of a corresponding row of A onto the basis formed by columns of V

$$A = U\Sigma V^T$$

$$\Rightarrow AV = U\Sigma V^T V = U\Sigma \Rightarrow U\Sigma = AV$$

- the i -th entry of a row of U is related to the projection of a corresponding row of A onto the i -th column of V
- Each row of V is related to the projection of a corresponding row of A^T onto the basis formed by U

$$A = U\Sigma V^T$$

$$\Rightarrow A^T U = (U\Sigma V^T)^T U = V\Sigma U^T U = V\Sigma$$

$$\Rightarrow V\Sigma = A^T U$$

- the i -th entry of a row of V is related to the projection of a corresponding row of A^T onto the i -th column of U

LSA Derivations (5/7)

- Fundamental comparisons based on SVD
 - The original word-document matrix (A)

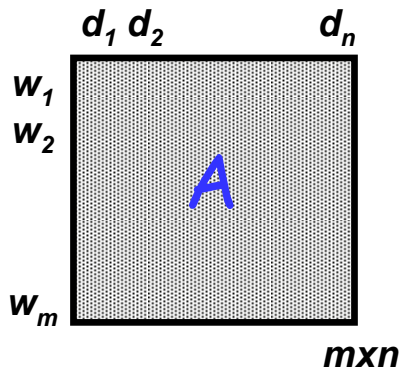

- compare two terms \rightarrow dot product of two rows of A
 - or an entry in AA^T
- compare two docs \rightarrow dot product of two columns of A
 - or an entry in $A^T A$
- compare a term and a doc \rightarrow each individual entry of A

- The new word-document matrix (A')

$$U' = U_{m \times k}$$

$$\Sigma' = \Sigma_k$$

$$V' = V_{n \times k}$$

- compare two terms $A'A^T = (U' \Sigma' V'^T) (U' \Sigma' V'^T)^T = U' \Sigma' V'^T V' \Sigma'^T U'^T = (U' \Sigma') (U' \Sigma')^T$
 - \rightarrow dot product of two rows of $U' \Sigma'$
- compare two docs $A^T A = (U' \Sigma' V'^T)^T (U' \Sigma' V'^T) = V' \Sigma'^T U'^T U' \Sigma' V'^T = (V' \Sigma') (V' \Sigma')^T$
 - \rightarrow dot product of two rows of $V' \Sigma'$
- compare a query word and a doc \rightarrow each individual entry of A'

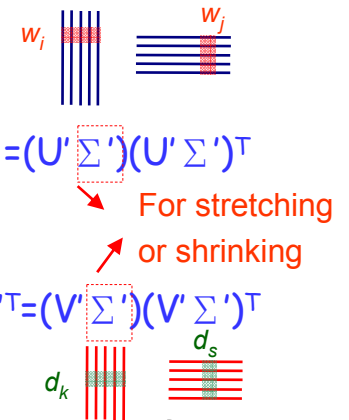

LSA Derivations (6/7)

- **Fold-in:** find representations for pseudo-docs q
 - For objects (new queries or docs) that did not appear in the original analysis
 - Fold-in a new $m \times 1$ query (or doc) vector

$$\hat{q}_{1 \times k} = \left(q^T \right)_{1 \times m} U_{m \times k} \Sigma^{-1}_{k \times k}$$

Just like a row of V Query represented by the weighted sum of its constituent term vectors The separate dimensions are differentially weighted

- Cosine measure between the query and doc vectors in the latent semantic space

$$\text{sim} \left(\hat{q}, \hat{d} \right) = \text{coine} \left(\hat{q} \Sigma, \hat{d} \Sigma \right) = \frac{\hat{q} \Sigma^2 \hat{d}^T}{\left| \hat{q} \Sigma \right| \left| \hat{d} \Sigma \right|}$$

row vectors

LSA Derivations (7/7)

- Fold-in a new 1 x n term vector

$$\hat{t}_{1 \times k} = t_{1 \times n} V_{n \times k} \Sigma_{k \times k}^{-1}$$

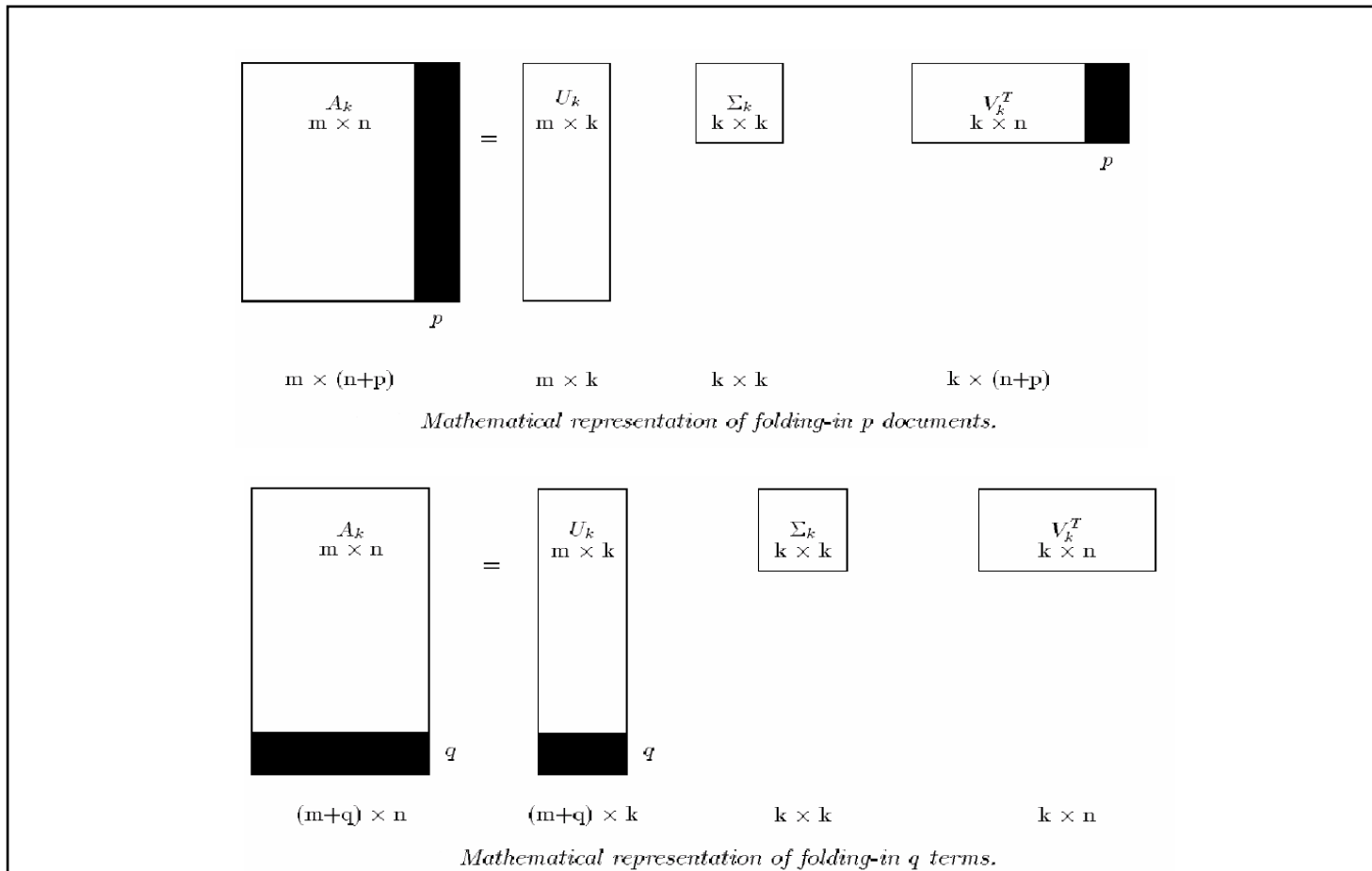

LSA Example

- Experimental results
 - HMM is consistently better than VSM at all recall levels
 - LSA is better than VSM at higher recall levels

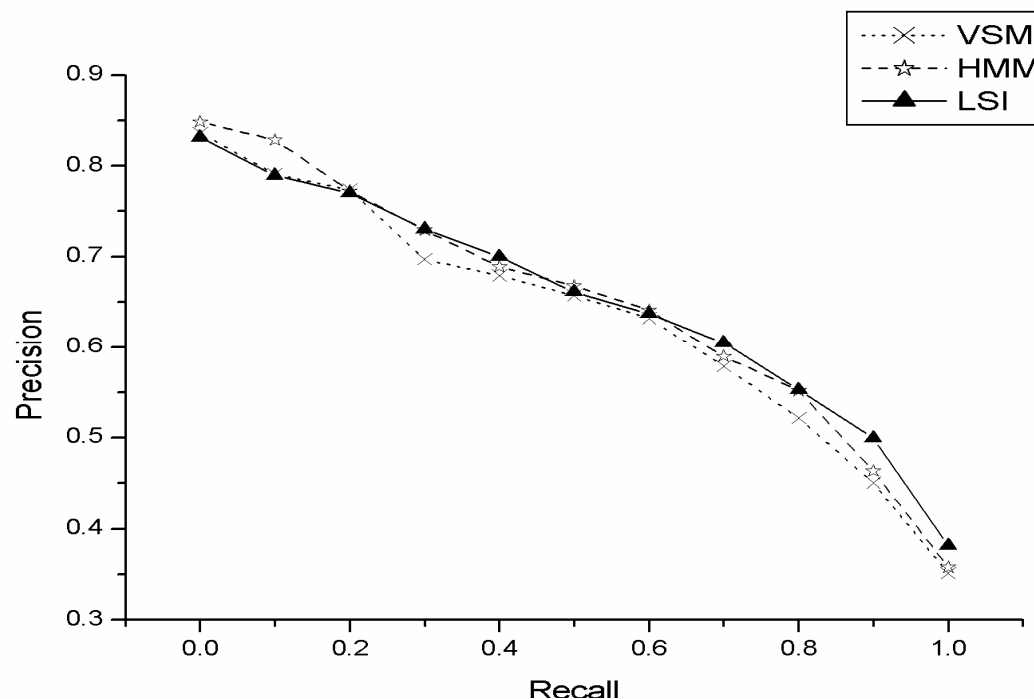

Recall-Precision curve at 11 standard recall levels evaluated on TDT-3 SD collection. (Using word-level indexing terms)

LSA: Conclusions

- Advantages
 - A clean formal framework and a clearly defined optimization criterion (least-squares)
 - Conceptual simplicity and clarity
 - Handle synonymy problems (“heterogeneous vocabulary”)
 - Good results for high-recall search
 - Take term co-occurrence into account
- Disadvantages
 - High computational complexity
 - LSA offers only a partial solution to polysemy
 - E.g. bank, bass,...

LSA Toolkit: SVDLIBC (1/5)

- Doug Rohde's SVD C Library version 1.3 is based on the [SVDPACKC](#) library
- Download it at <http://tedlab.mit.edu/~dr/>

LSA Toolkit: SVDLIBC (2/5)

- Given a sparse term-doc matrix

- E.g., 4 terms and 3 docs

	Doc		
Term	2.3	0.0	4.2
	0.0	1.3	2.2
	3.8	0.0	0.5
	0.0	0.0	0.0

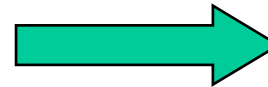

Row #Tem	Col. # Doc	Nonzero entries
4	3	6
2		2 nonzero entries at Col 0
0	2.3	Col 0, Row 0
2	3.8	Col 0, Row 2
1		1 nonzero entry at Col 1
1	1.3	Col 1, Row 1
3		3 nonzero entry at Col 2
0	4.2	Col 2, Row 0
1	2.2	Col 2, Row 1
2	0.5	Col 2, Row 2

- Each entry is weighted by *TFxIDF* score

- Perform SVD to obtain corresponding term and doc vectors represented in the latent semantic space
- Evaluate the information retrieval capability of the LSA approach by using varying sizes (e.g., 100, 200, ..,600 etc.) of LSA dimensionality

LSA Toolkit: SVDLIBC (3/5)

- Example: term-docmatrix

Indexing Term no.	Doc no.	Nonzero entries
51253	2265	218852
77		
508	7.725771	
596	16.213399	
612	13.080868	
709	7.725771	
713	7.725771	
744	7.725771	
1190	7.725771	
1200	16.213399	
1259	7.725771	

- SVD command (IR_svd.bat)

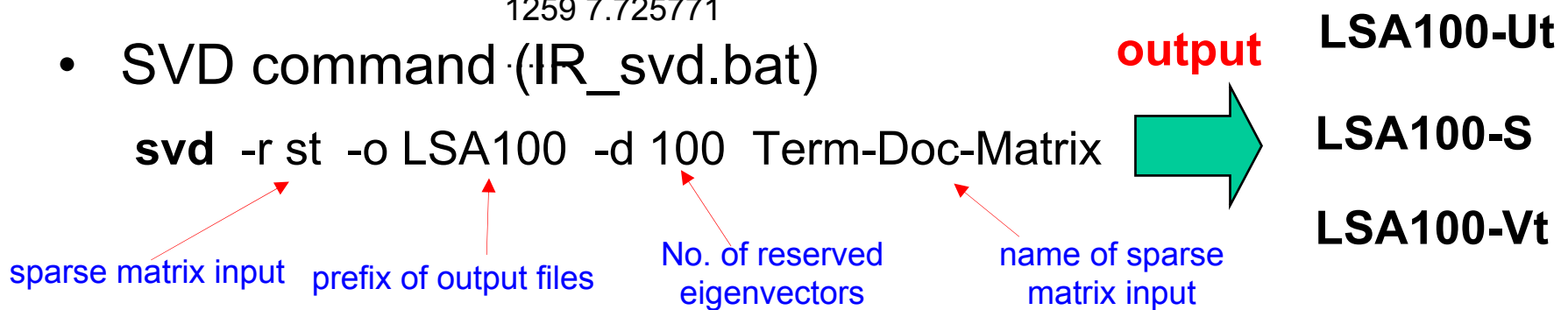

LSA Toolkit: SVDLIBC (4/5)

- **LSA100-Ut**

51253 words

100 51253

0.003 0.001

0.002 0.002

word vector (u^T): 1x100

- **LSA100-S**

100

2686.18

829.941

559.59

....

100 eigenvalues

- **LSA100-Vt** 2265 docs

100 2265

0.021 0.035

0.012 0.022

doc vector (v^T): 1x100

LSA Toolkit: SVDLIBC (5/5)

- Fold-in a new $m \times 1$ query vector

$$\hat{q}_{1 \times k} = \left(q^T \right)_{1 \times m} U_{m \times k} \Sigma_{k \times k}^{-1}$$

Just like a row of V

Query represented by the weighted sum of its constituent term vectors

The separate dimensions are differentially weighted

TFxIDF weighted beforehand

- Cosine measure between the query and doc vectors in the latent semantic space

$$\text{sim}(\hat{q}, \hat{d}) = \text{coine}(\hat{q}\Sigma, \hat{d}\Sigma) = \frac{\hat{q}\Sigma^2\hat{d}^T}{|\hat{q}\Sigma| |\hat{d}\Sigma|}$$